



mimanager

The logo consists of a black icon above the word "mimanager". The icon is a stylized shape that resembles a triangle with a curved top edge and a horizontal line extending from its base. The word "mimanager" is written in a bold, lowercase, sans-serif font.

SERVICIO ^{60'} EXPRESS

ROTULA A TU MANERA
AHORA EN 1 HORA!

SELLOS



60' mimanera

PLACAS HOMENAJE



60' mimanera

PLACAS (grabadas e impresas)



Metacrilato 60' mimanera



Acero 60' mimanera



Latón 60' mimanera

TROFEOS



Copas 60' mimanera



Metacrilato Personalizado 60' mimanera

MEDALLAS



60' mimanera

SERVICIO ^{60'} EXPRESS



TAZAS



60' mimanera

USB PERSONALIZADOS



60' mimanera

BOLÍGRAFOS



60' mimanera

ROLL-UPS



60' mimanera

BOTELLAS



60' mimanera

FUNDA MÓVIL



60' mimanera

AGENDAS



60' mimanera

ÍNDICE



01 Aluminio Composite

Dibond

02 Plásticos

Metacrilato

Placas

Planchas

Impreso

Letra recortada

Urna

Glass Pack

Polipropileno

Pvc

Cartón Pluma

Policarbonato Celular

Displays

03 Vinilo de Corte

Vinilo de Corte

Vinilo de Suelo

Vinilo Efecto Ácido

Lámina Solar

Efecto Espejo

04 Impresión Digital

Vinilo Impreso

V. Transparente Impreso

Microperforado

Polipropileno

Duratrans

Lona PVC

Imán

Lienzo

Papel

Vehículos

05 Rótulos

Sin Luz

Con Luz LED

06 Publicidad

Roll-Up

Pop-Up

Mostradores

Bandera Surf

Caballote

Marco Aluminio

Atril

Carpetas LED

Pantallas LED

07 Acero

Grabado Láser

Impreso

Letra Recortada

Letra Corpórea

08 Merchandising



Impresión Rígidos

Agenda Cannes

Bloc de Notas Kaffol

Bolígrafo Universal

Jarra Naimel

Cristal Nelumi

Fundas de Móvil

Pin Metálico

Linternas

Llavero Yip

Material de Oficina

Encendedor Fenick

Tazas

Usb Rebig 16Gb

Ordenador Portatil

Pelotas de Golf

Piel

Placas identificativas

Power Bank

Bolsa de Papel

Tarjetero

Posavasos

09 Calendarios

Feber

Faldilla PVC + Papel

10 Placas Homenaje

Pergamino

Rayos / Plix

Diamante / Azul

Plato

Borde Fino

Esquina Redondeada

Alpaca

Estuches

11 Trofeos

Copas

Medallas

Figuras

Cristal

Metacrilato

Personalizado

12 Grabaciones

13 Sellos

Automáticos

Clásicos de tampón

Fechadores

Numeradores

De Bolsillo

Seco

14 Imprenta

Tarjetas de Visita

Tarjetas de PVC

Hoja Corporativa

Sobres

Carpetas

Flyers

Díptico / Tríptico

15 Señalética

Evacuación, Advertencia

Contraincendios

Prohibición, Obligación

Varios

16 Textil

Camisetas

Bolsas

Mochilas

Gorras

01 ALUMINIO COMPOSITE

ALUMINIO COMPOSITE 01

DIBOND

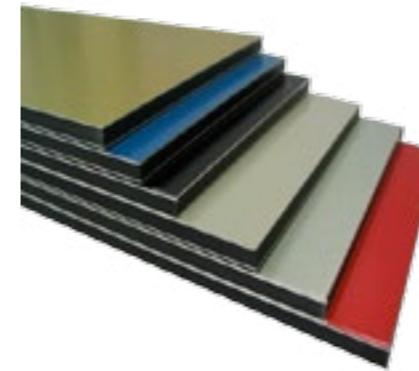

1. Soporte Dibond
2. Impresión directa sobre dibond

CARACTERISTICAS

Plancha Dibond Blanco 0.3mm
1500X3050X3mm

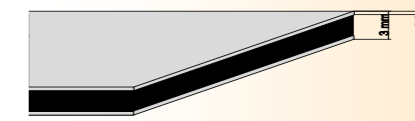

Plancha Dibond Blanco 0.2mm
1500X3050x3mm



Plancha Dibond Color 0.3mm
1500X3050x3mm



DIBOND ROTULADO

Menos de 1m²

Más de 1m²

Más de 5m²

Laminado

PRECIO IVA 21% PVP

184.50€ 38,74€ 223.24€

172.00€ 36.12€ 208.12€

216.00€ 45.36€ 261.36€

PRECIO IVA 21% PVP

70.00€/m² 14.70€ 84.70€

60.00€/m² 12.60€ 72.60€

50.00€/m² 10.50€ 60.50€

9.00€/m² 1.89€ 10.89€



PLACAS

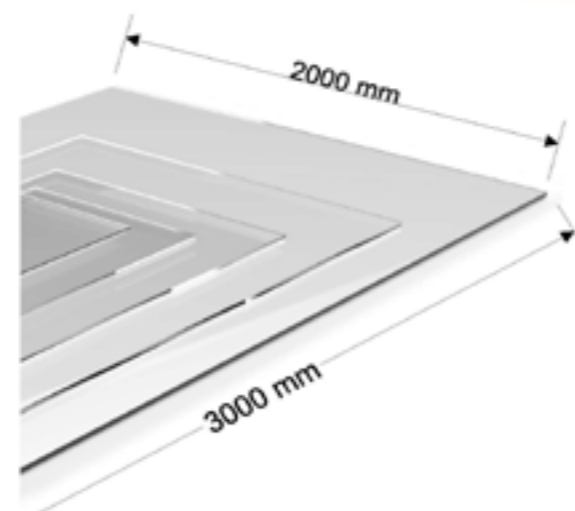

MEDIDAS CORTE A MEDIDA

	PRECIO	IVA 21%	PVP
1mm	20.00€/m ²	4.20€	24.20€/m ²
2mm	30.00€/m ²	6.60€	36.60€/m ²
3mm	40.00€/m ²	8.40€	48.40€/m ²
4mm	50.00€/m ²	10.50€	60.50€/m ²
5mm	70.00€/m ²	14.70€	84.70€/m ²
6mm	80.00€/m ²	16.80€	96.80€/m ²
8mm	100.00€/m ²	21.00€	121.00€/m ²
10mm	120.00€/m ²	45.20€	145.20€/m ²
15mm	180.00€/m ²	37.80€	217.80€/m ²
20mm	280.00€/m ²	58.80€	338.80€/m ²
25mm	360.00€/m ²	75.60€	435.60€/m ²

PLANCHAS

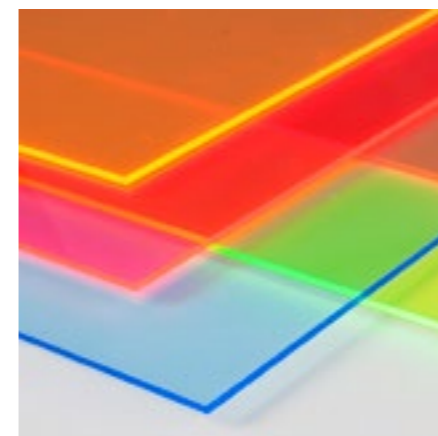

MEDIDAS CORTE PLANCHA ENTERA

	PRECIO	IVA 21%	PVP
2050 x 3050 x 3mm	35.00€/m ²	7.35€	42.35€/m ²
2050 x 3050 x 5mm	60.00€/m ²	12.60€	72.60€/m ²
2050 x 3050 x 8mm	82.00€/m ²	17.22€	99.22€/m ²
2050 x 3050 x 10mm	110.00€/m ²	23.10€	133.10€/m ²
2050 x 3050 x 15mm	160.00€/m ²	33.60€	193.60€/m ²
2050 x 3050 x 20mm	250.00€/m ²	52.50€	302.50€/m ²
2050 x 3050 x 25mm	330.00€/m ²	69€	399.30€/m ²



Corte + 10.00€

02 PLÁSTICOS METACRILATO IMPRESO

LETRAS METACRILATO PLÁSTICOS 02

METACRILATO IMPRESO

Impresión directa sobre el metacrilato



MEDIDAS	PRECIO	IVA 21%	PVP
Placa Pisos 70 x 70mm	7.00€	1.47€	8.47€
70 x 300mm	10.00€	2.10€	12.10€
Más de 10 uds. -15%			
150 x 230 x 3mm	40.00€	8.40€	48.40€
300 x 200 x 3mm	50.00€	10.50€	60.50€
300 x 200 x 5mm	55.00€	11.50€	66.50€
300 x 200 x 8mm	60.00€	12.60€	72.60€
350 x 250 x 3mm	62.00€	15.02€	75.02€
350 x 250 x 5mm	76.00€	15.96€	91.96€
350 x 250 x 8mm	82.00€	17.22€	99.22€
400 x 300 x 8mm	95.00€	19.95€	114.95€
500 x 700 x 8mm	135.00€	28.35€	163.35€

SUPERIOR A 500 x 700mm	PRECIO	IVA 21%	PVP
3mm	150.00€/m ²	31.50€	181.50€
5mm	180.00€/m ²	37.80€	217.80€
8mm	210.00€/m ²	44.10€	254.10€
15mm	380.00€/m ²	79.80€	459.80€
25mm	450.00€/m ²	94.50€	544.50€
25mm	550.00€/m ²	115.50€	665.50€



LETRAS RECORTADAS

Corte con láser



ALTURA	ESPESOR	PRECIO	IVA 21%	PVP
120 mm	3 mm	15.40€/ud	3.23€	18.63€
	5 mm	18.48€/ud	4.15€	22.63€
	8 mm	20.02€/ud	4.20€	24.22€
140 mm	3 mm	19.40€/ud	4.07€	23.47€
	5 mm	23.28€/ud	4.88€	28.16€
	8 mm	25.92€/ud	4.07€	31.36€
160 mm	3 mm	22.00€/ud	4.62€	26.62€
	5 mm	26.40€/ud	5.54€	31.94€
	8 mm	28.60€/ud	6.00€	34.60€
200 mm	3 mm	28.00€/ud	5.88€	33.88€
	5 mm	33.60€/ud	7.05€	40.65€
	8 mm	36.40€/ud	7.64€	44.04€
250 mm	3 mm	38.00€/ud	7.98€	45.98€
	5 mm	45.60€/ud	9.57€	55.17€
	8 mm	49.40€/ud	10.37€	59.77€
300 mm	3 mm	49.00€/ud	10.29€	59.29€
	5 mm	58.80€/ud	12.34€	71.14€
	8 mm	63.70€/ud	13.37€	77.07€
350 mm	3 mm	60.00€/ud	12.6€	72.6€
	5 mm	72.00€/ud	15.12€	87.12€
	8 mm	78.00€/ud	16.38€	94.38€

OPCIONES

+ Vinilo	+20%
+ Plix	+50%
+ Acero	+100%
+ Impresión Directa	+50%
+ de 10 letras	+25%

No incluye instalación - No incluyen elementos de sujeción

No incluye instalación - No incluyen elementos de sujeción

02 PLÁSTICOS URNAS METACRILATO

GLASS-PACK PLÁSTICOS 02

URNA

Metacrilato de 5mm de espesor



MEDIDAS

300 x 220 x 220mm
400 x 300 x 300mm

PRECIO IVA 21% PVP

68.00€ 14.28€ 82.28€
98.00€ 20.58€ 118.58€

URNA ABIERTA

Metacrilato de 5mm de espesor



MEDIDAS

400 x 200 x 400mm
650 x 300 x 300mm
500 x 450 x 300mm
200 x 300 x 200mm
1700 x 600 x 40mm

PRECIO IVA 21% PVP

92.00€ 19.32€ 111.32€
165.00€ 34.65€ 199.65€
175.00€ 36.75€ 211.75€
248.00€ 52.08€ 300.08€
399.00€ 83.79€ 482.79€

Para urnas con medidas determinadas, pedir presupuesto.

GLASS PACK

Hoja sin rotular



MEDIDAS PRECIO IVA 21% PVP

Blanco 700 x 1000mm 2.00€ 0.42€ 2.42€
Transparente 700 x 1000mm 3.00€ 0.63€ 3.63€

GLASS PACK

Glass Pack + Vinilo Impreso



MEDIDAS PRECIO IVA 21% PVP

500 x 350mm 8.00€/ud 1.68€ 9.68€
+ de 50 uds 3.65€/ud 0.76€ 4.41€
700 x 500mm 10.00€/ud 2.10€ 12.10€
+ de 30 uds 6.00€/ud 1.26€ 7.26€
1000 x 700mm 17.00€/ud 3.57€ 20.57€
2 uds 25.00€/ud 5.25€ 30.25€
10 uds 15.00€/ud 3.15€ 18.15€
+ de 50 uds 8.00€/ud 1.68€ 9.68€



Colocación gratuita de ollaos metálicos

02 PLÁSTICOS POLIPROPILENO

PVC / CARTÓN PLUMA PLÁSTICOS 02

POLIPROPILENO

Plancha

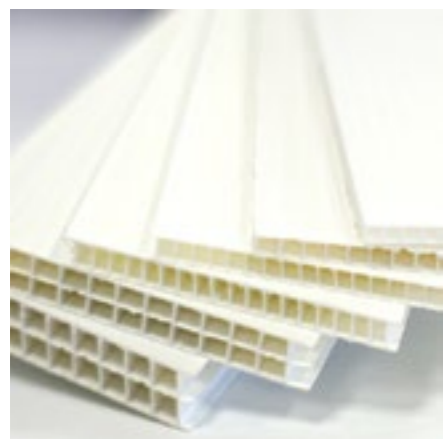

	MEDIDAS	PRECIO	IVA 21%	PVP
Polip	3,5mm/m2	10.00€/m2	2.10€	12.10€
Polip	5mm/m2	20.00€/m2	4.20€	24.20€
Polip	8mm/m2	30.00€/m2	6.30€	36.30€
Polip	10mm/m2	38.00€/m2	7.98€	45.98€

POLIPROPILENO

Rotulado



	MEDIDAS	PRECIO	IVA 21%	PVP
	500 x 350 x 3,5mm	9.00€/ud	1.89€	10.89€
	700 x 500 x 3,5mm + de 50 uds	15.00€/ud 7.00€/ud	3.15€ 1.47€	18.15€ 8.47€
	1000 x 700 x 3mm + de 30 uds	20.00€/ud 12.00€/ud	4.20€ 2.52€	24.20€ 14.52€



Colocación gratuita de ollaos metálicos

No incluye instalación - No incluyen elementos de sujeción

SOPORTE DE PVC

PVC + Vinilo + Laminado



CARTÓN PLUMA

+ Vinilo + Laminado



	MEDIDAS	PRECIO	IVA 21%	PVP
	3mm	69.00€/ud	14.49€	83.49€
	5mm	74.00€/ud	15.54€	89.54€
	8mm	86.00€/ud	18.06€	104.06€

+ de 10m2	en 3mm -30%Dto	48.30€/ud	10.14€	58.44€
+ de 10m2	en 5mm -30%Dto	51.80€/ud	10.89€	62.69€
+ de 10m2	en 8mm -30%Dto	60.20€/ud	12.64€	72.84€

	SIN ROTULAR	PRECIO	IVA 21%	PVP
	1mm	5.00€/m ²	1.05€	6.05€
	2mm	10.00€/m ²	2.10€	12.10€
	3mm	14.00€/m ²	2.94€	16.94€
	5mm	22.00€/m ²	4.62€	26.62€
	6mm	25.00€/m ²	5.25€	30.25€
	8mm	30.00€/m ²	6.30€	36.30€
	10mm	35.00€/m ²	7.35€	42.35€
	15mm	63.00€/m ²	13.23€	76.23€
	19mm	80.00€/m ²	16.80€	96.80€
	24mm	115.00€/m ²	24.15€	139.15€
	30mm	166.00€/m ²	34.86€	200.86€

	MEDIDAS	PRECIO	IVA 21%	PVP
	Menos de 5m ²			
	3mm	120.00€/m ²	25.20€	145.20€
	5mm	125.00€/m ²	26.25€	151.25€
	10mm	130.00€/m ²	27.30€	157.30€

	Más de 5m ²			
	3mm	45.00€/m ²	9.45€	54.45€
	5mm	50.00€/m ²	10.50€	60.50€
	10mm	65.00€/m ²	13.65€	78.65€

	Más de 10m ²			
	3mm	40.00€/m ²	8.40€	48.40€
	5mm	45.00€/m ²	9.45€	54.45€
	10mm	60.00€/m ²	12.60€	72.60€

IVA NO INCLUIDO

No incluye instalación - No incluyen elementos de sujeción

POLICARBONATO CELULAR

Sin rotular

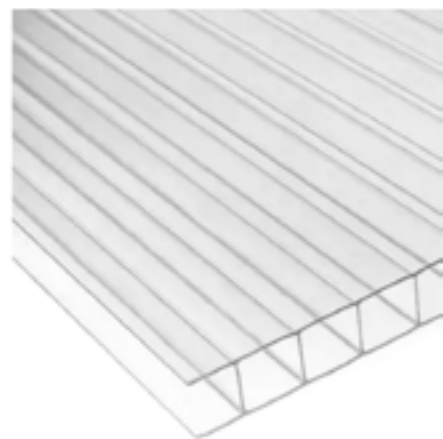

MEDIDAS	PRECIO	IVA 21%	PVP
6mm	29.00€/m ²	6.09€	35.09€
8mm	32.00€/m ²	6.72€	38.72€
10mm	34.00€/m ²	7.14€	41.14€
16mm	44.00€/m ²	9.24€	53.24€

Pedido mínimo 12m²
Para menos cantidad +50%

POLICARBONATO CELULAR

Rotulado

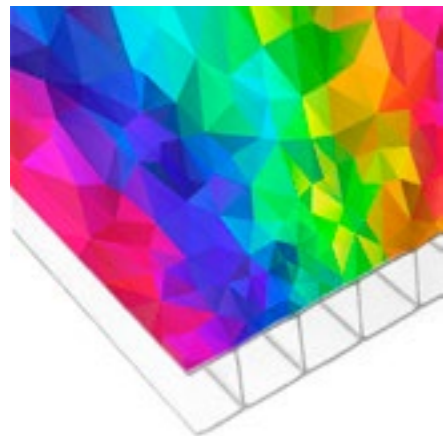

MEDIDAS	PRECIO	IVA 21%	PVP
6mm	60.00€/m ²	12.60€	72.60€
8mm	65.00€/m ²	13.65€	78.65€
10mm	68.00€/m ²	14.28€	82.28€
16mm	99.00€/m ²	20.79€	119.79€



Corte

10.00€



DISPLAYS DE METACRILATO



PORTACARTEL O PORTAPRECIOS SOBREMESA 1 CARA

Ref.	Descripción	Embalaje	Precio ud.
ZV-75	Portacartel Vertical 75x100mm.	48	4,46 €
ZV-100	Portacartel Vertical 100x150mm.	24	4,86 €
ZV-130	Portacartel Vertical 130x180mm.	24	5,03 €
ZV-150	Portacartel Vertical 150x200mm.	24	6,58 €
ZV-210	Portacartel Vertical 210x297mm.	24	7,41 €
ZH-150	Portacartel Horizontal 200x150mm.	24	5,58 €
ZH-210	Portacartel Horizontal 297x210mm.	24	7,41 €

PORTANOMBRE O PORTAPRECIOS 1 CARA

Ref.	Descripción	Embalaje	Precio ud.
SH-65	Soporte una cara 65x28mm.	24	3,43 €
ZH-50	Portacartel Horizontal 75x50mm.	48	3,55 €
ZV-50	Portacartel Vertical 50x75mm.	48	3,55 €
SH-105	Soporte una cara 105x60mm.	25	3,64 €
SH-210	Soporte una cara 210x60mm.	25	3,96 €

PORTANOMBRE O PORTAPRECIOS 2 CARAS

Ref.	Descripción	Embalaje	Precio ud.
VH-75	Soporte dos caras 75x50mm	48	3,90 €
VH-105	Soporte dos caras 105x65	24	4,02 €
VH-210	Soporte dos caras 210x70	24	5,23 €
VH-297	Soporte dos caras 297x70	24	6,23 €

PORTAMENU SOBREMESA

Ref.	Descripción	Embalaje	Precio ud.
LV-100	Portamenú Vertical 100x150mm.	12	5,35 €
LV-130	Portamenú Vertical 130x180mm.	12	5,75 €
LV-150	Portamenú Vertical 150x200mm.	12	6,99 €
LV-210	Portamenú Vertical 210x297mm.	12	9,13 €
LH-150	Portamenú Horizontal 150x200mm.	12	6,99 €
LH-210	Portamenú Horizontal 297x210mm.	12	9,13 €

PORTACARTEL DE PARED/COLGAR

Ref.	Descripción	Embalaje	Precio ud.
PCV-A5	Portacartel Vertical pared 148x210	30	6,50 €
PCV-A4	Portacartel Vertical pared 210x297	30	7,95 €
PCV-A3	Portacartel Vertical pared 297x420	20	10,31 €
PCH-A5	Portacartel Horiztal. pared 105x210	30	6,50 €
PCH-A4	Portacartel Horiztal. pared 210x297	30	7,95 €
PCH-A3	Portacartel Horiztal. pared 297x420	20	10,31 €

03 VINILO DE CORTE

VINILO DE CORTE 03

VINILO DE CORTE

Para vinilos de corte con más de 20 letras, preguntar precio.



MATERIAL

PRECIO IVA 21% PVP

MONOMÉRICO

Vinilo	35.00€/m ²	7.35€	42.35€/m ²
+ de 5m ²	18.00€/m ²	3.78€	21.78€/m ²
+ de 10m ²	15.00€/m ²	3.15€	18.15€/m ²

POLIMÉRICO

Vinilo	45.00€/m ²	9.45€	54.45€/m ²
+ de 5m ²	22.00€/m ²	4.62€	26.62€/m ²
+ de 10m ²	18.00€/m ²	3.78€	21.78€/m ²

FUNDICIÓN

Vinilo Blanco Impreso	45.00€/m ²	9.45€	54.45€/m ²
+ de 5m ²	40.00€/m ²	8.40€	48.40€/m ²
+ de 10m ²	38.00€/m ²	7.98€	45.98€/m ²

VINILO DE SUELO



VINILO IMPRESO m²

PRECIO IVA 21% PVP

Vinilo Impreso	36.00€/m ²	7.56€	43.56€
Vinilo Impreso Laminado	40.00€/m ²	8.40€	48.40€

Precio mínimo de impresión
Hora de diseño/maquetación personalizado

20.00€
28.00€/h

No incluye instalación - No incluyen elementos de sujección

03 VINILOS DE CORTE ESPECIALES

VINILO DE CORTE 03 ESPECIALES

VINILO EFECTO ÁCIDO

Instalación no incluida



LÁMINA SOLAR NEGRA

Instalación no incluida

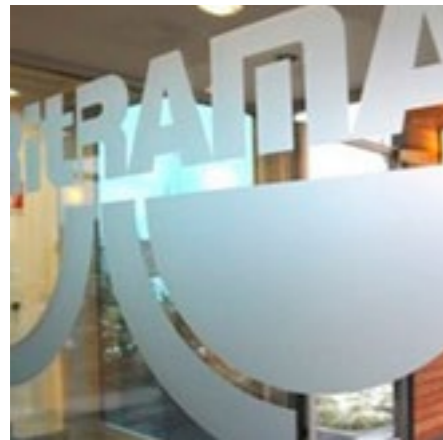

CANTIDAD	PRECIO	IVA 21%	PVP
Menos de 1 m ²	30.00€/m ²	6.30€	36.30€/m ²
1m ² a 5m ²	25.00€/m ²	5.25€	30.25€/m ²
+ de 5m ²	20.00€/m ²	4.20€	24.20€/m ²
+ de 10m ²	10.00€/m ²	2.10€	12.10€/m ²
Vinilo instalado + de 10m ²	20.00€/m ²	4.20€	24.20€/m ²

VINILO EFECTO ESPEJO

Instalación no incluida



PRECIO	IVA 21%	PVP
34.70€/m ²	7.28€	41.98€/m ²

PRECIO	IVA 21%	PVP
26.30€/m ²	5.52€	31.82€/m ²

04 IMPRESIÓN DIGITAL

IMPRESIÓN DIGITAL 04



VINILO IMPRESO



MATERIAL	PRECIO	IVA 21%	PVP
MONOMÉRICO			
Vinilo Blanco Impreso	30.00€/m ²	6.30€	36.30€
+ de 5m ²	15.00€/m ²	6.30€	36.30€
+ de 10m ²	10.00€/m ²	2.10€	12.10€
Laminado Monomérico	9.00€/m ²	7.35€	42.35€
+ de 5m ²	8.00€/m ²	2.52€	14.52€
+ de 10m ²	6.00€/m ²	7.35€	42.35€
POLIMÉRICO			
Vinilo Blanco Impreso	35.00€/m ²	6.30€	36.30€
+ de 5m ²	20.00€/m ²	6.30€	36.30€
+ de 10m ²	12.00€/m ²	2.10€	12.10€
Laminado Polimérico	12.00€/m ²	7.35€	36.30€
+ de 5m ²	10.00€/m ²	2.52€	36.30€
+ de 10m ²	8.00€/m ²	7.35€	12.10€
FUNDICIÓN			
Vinilo Blanco Impreso	45.00€/m ²	6.30€	36.30€
+ de 5m ²	40.00€/m ²	6.30€	36.30€
+ de 10m ²	38.00€/m ²	2.10€	12.10€
Laminado Fundición	30.00€/m ²	7.35€	36.30€
+ de 5m ²	25.00€/m ²	2.52€	36.30€
+ de 10m ²	23.00€/m ²	7.35€	12.10€

VINILO TRANSPARENTE IMPRESO



MATERIAL	PRECIO	IVA 21%	PVP
Vinilo Transparente	35.00€/m ²	7.35€	42.35€
Transparente + Blanco	60.00€/m ²	12.60€	72.60€
(en espejo)			
+ de 10m ²	15.00€/m ²	3.15€	18.15€
+ Vinilo Blanco	10.00€/m ²	2.10€	12.10€
Laminado Mate/Brillo	+ 9.00€		
+ de 10m ²	6.00€/m ²		

Precio mínimo de impresión

20.00€

Hora de diseño/maquetación personalizado

28.00€/h

No incluye instalación - No incluyen elementos de sujección

MICROPERFORADO

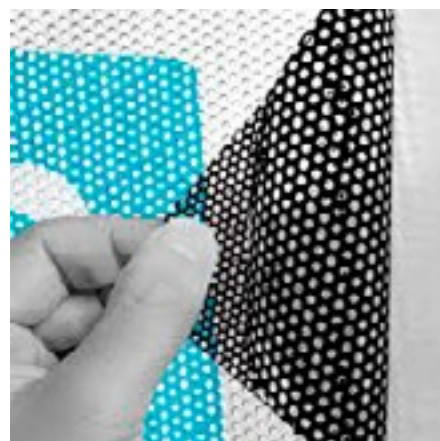

MATERIAL	PRECIO	IVA 21%	PVP
V. Microperforado	35.00€/m ²	7.35€	42.35€/m ²
+ de 5m ²	20.00€/m ²	4.20€	24.20€/m ²
+ de 10m ²	15.00€/m ²	3.15€	18.15€/m ²

POLIPROPILENO



MATERIAL	PRECIO	IVA 21%	PVP
Polipropileno	35.00€/m ²	7.35€	42.35€/m ²
+ de 10m ² . 30% dto	20.00€/m ²	4.20€	24.20€/m ²

Precio mínimo de impresión
Hora de diseño/maquetación personalizado

20€
28€/hora

No incluye instalación - No incluyen elementos de sujeción

DURATRANS

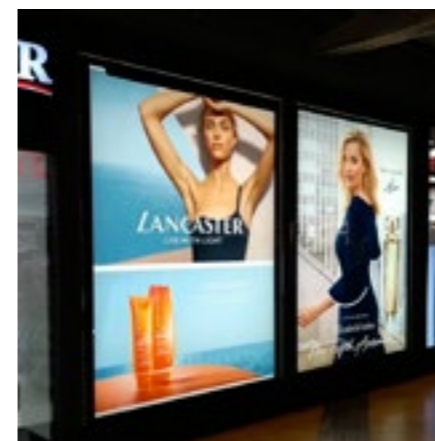

MATERIAL	PRECIO	IVA 21%	PVP
Duratrans	55.00€/m ²	11.55€	66.55€/m ²
+ de 10m ² , 30% dto	38.50€/m ²	8.08€	46.58€/m ²

LONA PVC



MATERIAL	PRECIO	IVA 21%	PVP
350gr/m ²	30.00€/m ²	6.30€	36.30€/m ²
550gr/m ²	35.00€/m ²	7.35€	42.35€/m ²
+ de 5m ²	15.00€/m ²	3.15€	18.15€/m ²
+ de 10m ²	20.00€/m ²	4.20€	24.20€/m ²
+ de 20m ²	10.00€/m ²	2.10€	12.10€/m ²
Lona Microperforada			
340gr. MESH	33.00€/m ²	6.93€	39.93€/m ²
+ de 5m ²	22.00€/m ²	4.62€	26.62€/m ²
+ de 10m ²	15.00€/m ²	3.15€	18.15€/m ²
+ de 20m ²	11.00€/m ²	2.31€	13.31€/m ²



Confección, ollas y refuerzo perimetral incluidos

Precio mínimo de impresión
Hora de diseño/maquetación personalizado

20€
28€/hora

No incluye instalación - No incluyen elementos de sujeción

04 IMPRESIÓN DIGITAL

IMPRESIÓN DIGITAL 04

IMÁN



MATERIAL

MATERIAL	PRECIO	IVA 21%	PVP
Imán	90.00€/m ²	18.90€	108.90€
850 x 550mm+ I.Digital			
100 uds	0.80€/ud	0.16€	0.96€/ud
250 uds	0.63€/ud	0.13€	0.76€/ud
500 uds	0.47€/ud	0.09€	0.56€/ud
1000 uds	0.39€/ud	0.08€	0.47€/ud
PLIEGO SIN CORTAR			
50 x 50mm x 1000uds	0.15€/ud	0.03€	0.18€/ud
60 x 60mm x 1000uds	0.18€/ud	0.03€	0.21€/ud
85 x 55mm x 1000uds	0.20€/ud	0.04€	0.24€/ud

LIENZO



MATERIAL

MATERIAL	PRECIO	IVA 21%	PVP
Lienzo	95.00€/m ²	19.95€	114.95€/m ²
+ de 5m ² , 30% dto	66.50€/ud	13.96€	80.46€/ud
+ de 10m ²	40.00€/m ²	8.40€	48.40€/m ²
+ Bastidor madera	50.00€/ud	10.50€	60.50€/ud



20€
28€/hora

Precio minimo de impresión
Hora de diseño/maquetación personalizado

No incluye instalación - No incluyen elementos de sujeción

PAPEL



CANTIDAD

CANTIDAD	PRECIO	IVA 21%	PVP
Papel 200gr/m ² + de 10m ² , 30% dto	20.00€/m ² 10.00€/m ²	4.20€ 2.10€	24.20€/m ² 12.10€/m ²

VEHÍCULOS



MATERIAL

MATERIAL	PRECIO	IVA 21%	PVP
Vinilo de Fundición + Laminado	90.00€/m ²	18.90€	108.90€/m ²

Precio minimo de impresión
Hora de diseño/maquetación personalizado

20€
28€/hora

No incluye instalación - No incluyen elementos de sujeción

05 RÓTULOS

SIN LUZ RÓTULOS 05

BANDEJA PLEGADA ROTULADA



MATERIAL	PRECIO	IVA 21%	PVP
Menos de 1m ² Mínimo	180.00€/m ²	37.80€	217.80€/m ²
Aluminio 2mm + de 5m ² + de 10m ²	205.00€/m ² 190.00€/m ² 180.00€/m ²	43.05€ 39.90€ 37.80€	248.05€/m ² 229.90€/m ² 217.80€/m ²
Composite 3mm + de 5m ² + de 10m ²	235.00€/m ² 210.00€/m ² 190.00€/m ²	49.35€ 44.10€ 39.90€	284.35€/m ² 254.10€/m ² 229.90€/m ²

BANDEROLA PVC / COMPOSITE



TIPO	PRECIO	IVA 21%	PVP
PVC			
50X70cm 16mm	141.00€/m ²	29.61€	170.61€/m ²
60x80cm 16mm	171.00€/m ²	35.91€	206.91€/m ²
70X100cm 16mm	198.00€/m ²	41.58€	239.58€/m ²
Composite			
50X70cm 3mm	134.00€/m ²	28.14€	162.14€/m ²
60x80cm 3mm	167.00€/m ²	35.07€	202.07€/m ²
70X100cm 3mm	185.00€/m ²	38.85€	223.85€/m ²

Hora de diseño/maquetación personalizado 28€/hora

No incluye instalación - No incluyen elementos de sujeción

05 RÓTULOS SIN LUZ

SIN LUZ RÓTULOS 05

PVC CORPÓREO



ESPESOR PRECIO IVA 21% PVP

3mm	90.00€/m ²	18.90€	108.90€/m ²
5mm	110.00€/m ²	23.10€	133.10€/m ²
8mm	115.00€/m ²	15.85€	139.15€/m ²
10mm	125.00€/m ²	26.25€	151.25€/m ²
15mm	160.00€/m ²	33.60€	193.60€/m ²
20mm	180.00€/m ²	37.80€	217.80€/m ²
25mm	270.00€/m ²	56.70€	326.70€/m ²
30mm	339.00€/m ²	71.19€	410.19€/m ²

Consultar precio para otras cantidades

LONA CON BASTIDOR



TIPO PRECIO IVA 21% PVP

Lona Backlight + Estructura Tubular	190.00€/m ²	39.90€	229.90€/m ²
-------------------------------------	------------------------	--------	------------------------

Hora de diseño/maquetación personalizado 28€/hora

No incluye instalación - No incluyen elementos de sujeción

ACERO CORPÓREO



ALTURA DE LETRA

200mm	77.00€/m ²	16.17€	93.17€/m ²
300mm	96.00€/m ²	20.16€	116.16€/m ²
400mm	120.00€/m ²	25.20€	145.20€/m ²
600mm	155.00€/m ²	32.55€	187.55€/m ²
800mm	185.00€/m ²	38.85€	223.85€/m ²



Grosor de 70mm

MARCO JUNQUILLO

Metacrilato de 3mm
Rotulación incluida



ALTURA PRECIO IVA 21% PVP

30cm	90.00€/m	18.90€	108.90€/m
40cm	110.00€/m	23.10€	133.10€/m
50cm	120.00€/m	25.20€	145.20€/m
60cm	135.00€/m	28.35€	163.35€/m
70cm	140.00€/m	29.40€	169.40€/m
80cm	150.00€/m	31.50€	181.50€/m
90cm	160.00€/m	33.60€	193.60€/m
100cm	190.00€/m	39.90€	229.90€/m

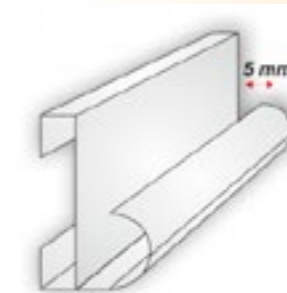

Hora de diseño/maquetación personalizado 28€/hora

No incluye instalación - No incluyen elementos de sujeción

05 RÓTULOS CON LUZ LED

CON LUZ LED RÓTULOS 05

LUMINARIA

Metacrilato de 5mm
Rotulación incluida

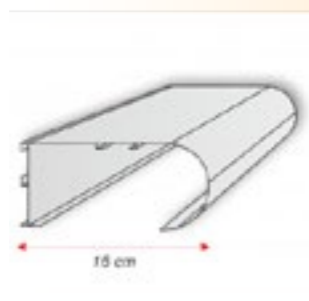

ALTURA	PRECIO	IVA 21%	PVP
40cm	212.00€/m	44.52€	256.52€/m
50cm	230.00€/m	48.30€	278.30€/m
60cm	250.00€/m	52.50€	302.50€/m
70cm	280.00€/m	58.80€	338.80€/m
80cm	310.00€/m	65.10€	375.10€/m

BANDEROLA



MEDIDAS	PRECIO	IVA 21%	PVP
500 x 500mm	178.00€	37.38€	215.38€
700 x 400mm	184.60€	38.76€	223.36€
600 x 500mm	185.50€	38.95€	224.45€
700 x 500mm	191.10€	40.13€	231.23€
800 x 600mm	223.60€	46.95€	270.55€
1000 x 600mm	250.50€	52.50€	302.50€
1300 x 600mm	292.50€	61.40€	353.92€
1300 x 800mm	344.50€	72.34€	416.84€
A Medida	178.00€	28.77€	165.77€/m²

Hora de diseño/maquetación personalizado

28€/hora

BANDEJA ALUMINIO CON LETRA EN RELIEVE RETROILUMINADA

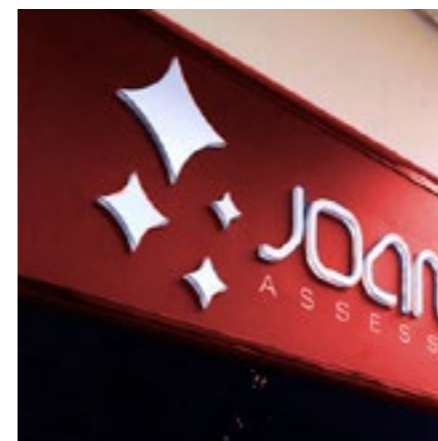

MATERIAL	PRECIO	IVA 21%	PVP
Metacrilato Personalizado	400.00€/m²	84.00€	484.00€/m²

PLAFÓN LUMINOSO



	PRECIO	IVA 21%	PVP
600 x 1000mm	197.60€	41.49€	239.09€
600 x 1500mm	272.61€	57.24€	329.85€
600 x 2000mm	330.20€	69.34€	399.54€
600 x 2500mm	426.40€	40.13€	231.23€
600 x 3000mm	494.00€	103.74€	597.74€
A Medida			
Menos de 1m²	330.00€/m²	69.30€	399.30€
Más de 5m²	295.00€/m²	61.95€	356.95€
Más de 10m²	250.00€/m²	52.50€	302.50€

Hora de diseño/maquetación personalizado

28€/hora

05 RÓTULOS CON LUZ LED

CON LUZ LED RÓTULOS 05

LETRA CORPÓREA EN METACRILATO

Mínimo 5 Letras



ESTILO LETRA

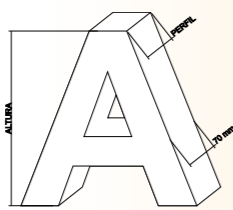

Estilo Arial

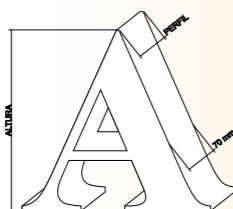

Estilo Times

ALT X 4	PRECIO	IVA 21%	PVP
200 x 70mm	mínimo 120.00€	25.20€	145.20€
300 x 70mm	120.00€	25.20€	145.20€
400 x 70mm	160.00€	33.60€	193.60€
500 x 70mm	200.00€	42.00€	242.00€
600 x 70mm	240.00€	50.40€	290.40€
800 x 70mm	320.00€	67.20€	387.20€

ALT X 5	PRECIO	IVA 21%	PVP
200 x 70mm	mínimo 120.00€	25.20€	145.20€
300 x 70mm	150.00€	31.50€	181.50€
400 x 70mm	200.00€	42.00€	242.00€
500 x 70mm	250.00€	52.50€	302.50€
600 x 70mm	300.00€	63.00€	363.00€
800 x 70mm	400.00€	84.00€	484.00€

LETRA EN ALUMINIO CORPÓREA



Aluminio 1.5mm
Pintado en su color

ALTURA X GROSOR DE LETRA	PRECIO	IVA 21%	PVP
200 x 50mm	55.30€/ud	11.61€	66.91€/ud
300 x 50mm	84.50€/ud	17.74€	102.24€/ud
400 x 50mm	120.90€/ud	25.38€	146.28€/ud
600 x 50mm	274.30€/ud	57.60€	331.90€/ud

Hora de diseño/maquetación personalizado 28€/hora

LETRA EN ACERO CORPÓREA



Acero Satinado

ALTURA X GROSOR DE LETRA	PRECIO	IVA 21%	PVP
200mm	67.60€/ud	14.19€	81.79€/ud
300mm	107.90€/ud	22.65€	130.55€/ud
400mm	157.30€/ud	33.03€	190.33€/ud
600mm	349.70€/ud	13.43€	423.13€/ud

LETRA EN PVC RETROILUMINADO



Pvc 19mm espesor
Pintado en su color

ALTURA X GROSOR DE LETRA	PRECIO	IVA 21%	PVP
200 x 19mm	80.60€/ud	16.92€	97.52€/ud
300 x 19mm	111.80€/ud	23.47€	135.27€/ud
400 x 19mm	137.80€/ud	28.93€	166.73€/ud
600 x 19mm	208.00€/ud	43.68€	251.68€/ud
700 x 19mm	247.00€/ud	51.87€	298.87€/ud
800 x 19mm	279.50€/ud	58.69€	338.19€/ud
900 x 19mm	310.70€/ud	65.24€	375.94€/ud

Hora de diseño/maquetación personalizado 28€/hora

NEÓN GAS

50.00€ metro lineal



ALTURA X 3	LONGITUD	PRECIO	IVA 21%	PVP
30cm x 3	90cm	45.00€	9.45€	54.45€
40cm x 3	120cm	60.00€	12.60€	72.60€
50cm x 3	150cm	75.00€	15.75€	90.75€
60cm x 3	180cm	90.00€	18.90€	108.90€

NEÓN GAS

50.00€ metro lineal



ALTURA X 5	LONGITUD	PRECIO	IVA 21%	PVP
30cm x 5	150cm	75.00€	15.75€	90.75€
40cm x 5	200cm	100.00€	21.00€	121.00€
50cm x 5	250cm	125.00€	26.25€	151.25€
60cm x 5	300cm	150.00€	31.50€	181.50€

NEÓN GAS

50.00€ metro lineal



ALTURA X 7	LONGITUD	PRECIO	IVA 21%	PVP
30cm x 7	210cm	105.00€	22.05€	127.05€
40cm x 7	280cm	140.00€	29.40€	169.40€
50cm x 7	350cm	175.00€	36.75€	211.75€
60cm x 7	420cm	210.00€	44.10€	254.10€

LED NEÓN

30.00€ metro lineal

No se recomienda su uso en exterior



ALTURA X 3	LONGITUD	PRECIO	IVA 21%	PVP
30cm x 3	90cm	27.00€	5.67€	32.67€
40cm x 3	120cm	36.00€	7.56€	43.56€
50cm x 3	150cm	45.00€	9.45€	54.45€
60cm x 3	180cm	54.00€	11.34€	65.34€

LED NEÓN

30.00€ metro lineal



ALTURA X 5	LONGITUD	PRECIO	IVA 21%	PVP
30cm x 5	150cm	45.00€	9.45€	54.45€
40cm x 5	200cm	60.00€	12.60€	72.60€
50cm x 5	250cm	75.00€	15.75€	90.75€
60cm x 5	300cm	90.00€	18.90€	108.90€

LED NEÓN

30.00€ metro lineal



ALTURA X 7	LONGITUD	PRECIO	IVA 21%	PVP
30cm x 7	210cm	63.00€	13.23€	76.23€
40cm x 7	280cm	84.00€	17.64€	101.64€
50cm x 7	350cm	105.00€	22.05€	127.05€
60cm x 7	420cm	126.00€	26.46€	152.46€

05 RÓTULOS SEÑALÉTICA SLATZS PLANO

SLATZS CURVO RÓTULOS 05 SEÑALÉTICA

SLATZS PLANO

REF - ALTO X ANCHO

PRECIO IVA 21% PVP



789/M 8 x 24 cm
789/M 8 x 32 cm
789/M 8 x 48 cm

32.46€ 6.81€ 39.27€
23.21€ 4.87€ 28.08€
30.36€ 6.37€ 36.73€



789/P Doble Cara 8 x 24 cm
789/P Doble Cara 8 x 32 cm
789/P Doble Cara 8 x 48 cm

96.88€ 20.34€ 117.22€
109.55€ 23.00€ 132.55€
134.61€ 28.26€ 162.87€



789/S 2C colgante 8 x 48 cm
789/S 2C colgante 8 x 64 cm
789/S 2C colgante 8 x 96 cm

150.65€ 31.63€ 182.28€
170.24€ 35.75€ 205.99€
209.88€ 44.07€ 253.95€

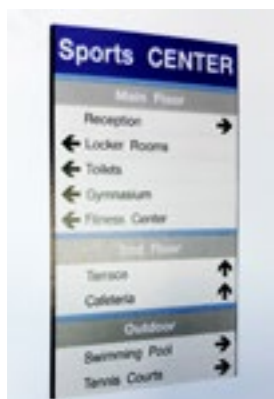

790/D 8 x 24 cm (Lama)
790/D 8 x 32 cm (Lama)
790/D 8 x 48 cm (Lama)

31.31€ 6.57€ 37.88€
33.65€ 7.06€ 40.71€
38.29€ 8.04€ 46.33€

Soporte lamas consultar

Rotulación sobre Glass Pack de 0,8mm. +8.00€ ud.
Hora de diseño/maquetación personalizado: 28€/hora

No incluye instalación - No incluyen elementos de sujeción

SLATZS CURVO

REF - ALTO X ANCHO

PRECIO IVA 21% PVP



793/M 12 x 12 cm
793/M 15 x 15 cm
793/M 21 x 21 cm

16.98€ 3.56€ 20.54€
22.81€ 4.79€ 27.60€
33.68€ 7.07€ 40.75€



799/M 8 x 12 cm
799/M 8 x 24mm
799/M 8 x 32 cm
799/M 8 x 48mm

14.11€ 2.96€ 17.07€
17.02€ 3.57€ 20.59€
18.85€ 3.95€ 22.80€
22.08€ 4.63€ 26.71€



793/P Doble cara 15 x 15 cm
793/P Doble cara 21 x 21 cm
793/P Doble cara 30 x 30 cm

91.56€ 19.22€ 110.78€
106.31€ 22.32€ 128.63€
272.99€ 57.32€ 330.31€

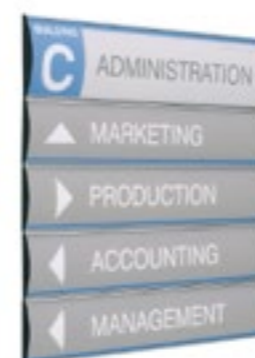

799/M 8 x 24 cm (Lama)
799/M 8 x 32mm (Lama)
799/M 8 x 48 cm (Lama)

17.02€ 3.57€ 20.59€
18.85€ 3.95€ 22.80€
22.08€ 4.63€ 26.71€

Soporte lamas consultar

Rotulación sobre Glass Pack de 0.8mm. +8.00€ ud.
Hora de diseño/maquetación personalizado: 28€/hora

No incluye instalación - No incluyen elementos de sujeción

06 PUBLICIDAD



PUBLICIDAD 06

ROLL-UP



MEDIDAS/ LONA

	PRECIO	IVA 21%	PVP
850 x 2000mm	49.99€/ud	10.49€	60.48€/ud
+ de 3 uds	44.99€/ud	9.44€	54.43€/ud
+ de 6 uds	39.99€/ud	8.39€	48.38€/ud
1000 x 2000mm	90.00€/ud	18.90€	108.90€/ud
1200 x 2000mm	130.00€/ud	27.30€	157.30€/ud
1500 x 2000mm	160.00€/ud	33.60€	193.60€/ud

MEDIDAS POLIPROPILENO

	PRECIO	IVA 21%	PVP
850 x 2000mm	49.99€/ud	10.49€	60.48€/ud
+ de 3 uds	44.99€/ud	9.44€	54.43€/ud
+ de 6 uds	39.99€/ud	8.39€	48.38€/ud
1000 x 2000mm	90.00€/ud	18.90€	108.90€/ud
1200 x 2000mm	130.00€/ud	27.30€	157.30€/ud
1500 x 2000mm	160.00€/ud	33.60€	193.60€/ud

Hora de diseño/maquetación personalizado

28€/hora

No incluye instalación - No incluyen elementos de sujección

POP-UP



Impresión Full color

MEDIDAS DE GRÁFICA

MEDIDAS DE GRÁFICA	PRECIO	IVA 21%	PVP
2240 x 2240mm	295.00€/ud	61.95€	356.95€/ud
2990 x 2240mm	390.00€/ud	81.90€	471.90€/ud
3800 x 2300mm	490.00€/ud	102.90€	592.90€/ud

TROLLEY



Incluye maleta tipo Trolley

Hora de diseño/maquetación personalizado

28€/hora

No incluye instalación - No incluyen elementos de sujeción

MOSTRADOR CURVO



Impresión Full color

MEDIDAS PRECIO IVA 21% PVP

MEDIDAS	PRECIO	IVA 21%	PVP
295 x 950 x 1055mm	260.00€/ud	54.60€	314.60€/ud
+ de 3 uds	221.00€/ud	46.41€	267.41€/ud
+ de 6 uds	182.00€/ud	38.22€	220.22€/ud

Incluye maleta tipo Trolley

MOSTRADOR LIGERO



Impresión Full color

CARACTERÍSTICAS PRECIO IVA 21% PVP

CARACTERÍSTICAS	PRECIO	IVA 21%	PVP
Altura 1910mm Ancho 880mm	195.00€/ud	40.95€	235.95€/ud
Gráfica superior 740x240mm Gráfica Inferior 810 x 880mm Gráfica Lateral X2 880 x 420mm			
Incluye Bolsa de transporte			

Hora de diseño/maquetación personalizado

28€/hora

No incluye instalación - No incluyen elementos de sujeción

BANDERAS



SURF

GOTA

Hora de diseño/maquetación personalizado

28€/hora

MEDIDAS

PRECIO IVA 21% PVP

Altura 290cm Gráfica 2200 x 500mm	87.14€/ud	18.29€	105.43€/ud
Altura 3400mm Gráfica 2660 x 600mm	100.51€/ud	21.10€	121.61€/ud
Altura 4000mm Gráfica 3460 x 700mm	113.87€/ud	23.91€	137.78€/ud
Altura 5000mm Gráfica 4000 x 700mm	130.96€/ud	27.50€	158.46€/ud
Altura 6000mm Gráfica 500 x 80cm	157.84€/ud	33.14€	190.98€/ud

No incluye instalación - No incluyen elementos de sujeción

CABALLETE ALUMINIO



CABALLETE PIZARRA



Hora de diseño/maquetación personalizado

28€/hora

MEDIDAS PRECIO IVA 21% PVP

500 x 700mm	125.00€/ud	26.25€	151.25€/ud
700 x 1000mm	175.00€/ud	36.75€	211.75€/ud

PRECIO IVA 21% PVP

650 x 1100mm	75.80€/ud	15.91€	91.71€/ud
--------------	-----------	--------	-----------

No incluye instalación - No incluyen elementos de sujeción

MARCO DE PARED ALUMINIO



MEDIDAS	PRECIO	IVA 21%	PVP
500 x 700mm	49.50€/ud	10.39€	59.89€/ud
700 x 1000mm	75.00€/ud	15.75€	90.75€/u

ATRIL PORTAFOLLETOS



	PRECIO	IVA 21%	PVP
1170mm Portafolletos A4	59.90€/ud	12.57€	72.47€/ud

Hora de diseño/maquetación personalizado 28€/hora

No incluye instalación - No incluyen elementos de sujeción

CARPETAS LUMINOSAS LED



TAMAÑO	PRECIO	IVA 21%	PVP
A3 - 297 x 420mm Mínimo 6uds.	139.00€/ud	29.19€	168.19€/ud
A4 - 210 x 297mm Mínimo 6uds.	120.00€/ud	25.20€	145.20€/ud



Hora de diseño/maquetación personalizado 28€/hora

No incluye instalación - No incluyen elementos de sujeción

06 PUBLICIDAD

PANTALLA LED EXTERIOR P4



CARACTERISTICAS

Pantalla Full Color P4
Apertura trasera
Gama Profesional
Alto rendimiento
Control remoto
Servidor Cosmi
Wifi 3G/4G
Sensor de Temperatura

Menos de 1m²
consultar precio.

PRECIO 1850.00€/m²

IVA 21% 388.50€

PVP 2238.50€/ud

PANTALLA LED EXTERIOR P6



Pantalla Full Color P6
Apertura trasera
Gama Profesional
Alto rendimiento
Control remoto
Servidor Cosmi
Wifi 3G/4G
Sensor de Temperatura

Menos de 1m²
consultar precio.

PRECIO 1500.00€/m²

IVA 21% 315.00€

PVP 1815.00€/ud

Hora de diseño/maquetación personalizado 28€/hora

No incluye instalación - No incluyen elementos de sujeción

ACERO 07

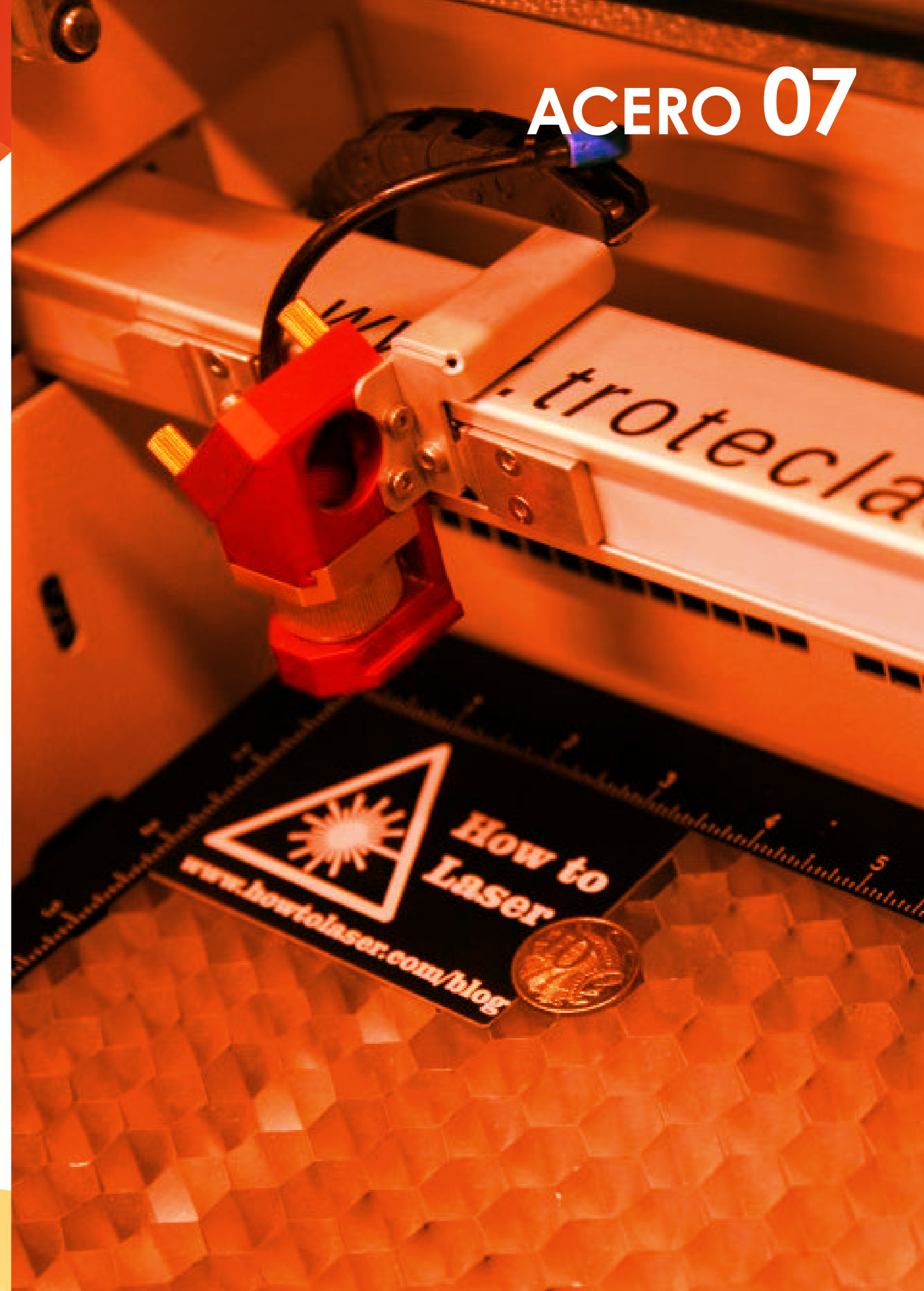

GRABADO CON LÁSER



MEDIDAS	PRECIO	IVA 21%	PVP
100 x 150mm	30.00€/ud	6.30€	36.30€/ud
200 x 150mm	50.00€/ud	1.21€	60.50€/ud
300 x 200mm	80.00€/ud	16.80€	96.80€/ud
350 x 250mm	120.00€/ud	25.20€	145.20€/ud
400 x 300mm	150.00€/ud	31.50€	181.50€/ud
600 x 300mm	230.00€/ud	48.30€	278.30€/ud

IMPRESIÓN DIRECTA



	PRECIO	IVA 21%	PVP
100 x 150mm	30.00€/ud	6.30€	36.30€/ud
200 x 150mm	50.00€/ud	1.21€	60.50€/ud
300 x 200mm	80.00€/ud	16.80€	96.80€/ud
350 x 250mm	120.00€/ud	25.20€	145.20€/ud
400 x 300mm	150.00€/ud	31.50€	181.50€/ud
600 x 300mm	230.00€/ud	48.30€	278.30€/ud

Barniz UVI +10.00€

Hora de diseño/maquetación personalizado 28€/hora

No incluye instalación - No incluyen elementos de sujeción

LETRA RECORTADA



ALTURA DE LETRA	PRECIO	IVA 21%	PVP
100mm	7.10€/ud	1.49€	8.59€/ud
120mm	8.40€/ud	1.76€	10.64€/ud
140mm	10.40€/ud	2.18€	12.58€/ud
160mm	13.00€/ud	2.73€	15.73€/ud
200mm	16.00€/ud	3.36€	19.36€/ud
250mm	19.00€/ud	3.99€	22.99€/ud
300mm	23.00€/ud	4.83€	27.83€/ud
500mm	32.00€/ud	6,72€	38.72€/ud

LETRA CORPÓREA ALTURA



ALTURA	SIN LUZ PRECIO	IVA 21%	PVP	CON LUZ PRECIO	IVA 21%	PVP
150mm	78.30€/ud	16.44 €	94.74€/ud	113.00€/ud	23.73€	136.73€/ud
200mm	84.05€/ud	17.65€	101.70€/ud	123.00€/ud	25.83€	148.83€/ud
250mm	97.50€/ud	20.47€	117.97€/ud	129.00€/ud	27.09€	156.09€/ud
300mm	105.00€/ud	22.05€	127.50€/ud	159.00€/ud	33.39€	192.39€/ud
400mm	130.00€/ud	27.30€	157.30€/ud	199.00€/ud	41.79€	240.79€/ud
500mm	165.00€/ud	34.65€	199.65€/ud	247.00€/ud	51.87€	298.87€/ud
600mm	185.00€/ud	38.85€	223.85€/ud	290.00€/ud	60.90€	350.90€/ud
800mm	249.00€/ud	52.29€	301.29€/ud	366.00€/ud	76.86€	442.86€/ud
1000mm	295.00€/ud	61.95€	356.95€/ud	499.00€/ud	104.79€	603.79€/ud

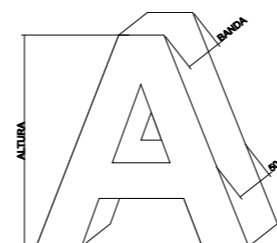

Hora de diseño/maquetación personalizado 28€/hora

No incluye instalación - No incluyen elementos de sujeción

08 MERCHANDISING

IMPRESIÓN SOBRE RÍGIDOS



MERCHANDISING 08

IMPRESIÓN SOBRE RÍGIDOS

PUESTA EN MARCHA 24.80€ +iva

AGENDA CANNES



UDS	PRECIO	IMPRESIÓN	SUBTOTAL	IVA 21%	TOTAL
100 uds	2.63€/ud	P 0.20€/ud G 0.60€/ud	2.83€/ud 3.23€/ud	0.59€ 0.67€	3.42€/ud 3.91€/ud
200 uds	2.60€/ud	P 0.15€/ud G 0.50€/ud	2.75€/ud 3.10€/ud	0.58€ 0.65€	3.33€/ud 3.75€/ud
500 uds	2.50€/ud	P 0.14€/ud G 0.40€/ud	2.65€/ud 2.90€/ud	0.56€ 0.61€	3.21€/ud 3.51€/ud
1000 uds	2.50€/ud	P 0.14€/ud G 0.40€/ud	2.65€/ud 2.90€/ud	0.56€ 0.61€	3.21€/ud 3.51€/ud



Área Grande



Área Pequeña

+ Barniz UVI - P 0.20€/ud
G 0.50€/ud

+ Tinta Blanca - P 0.20€/ud
G 0.50€/ud

BLOC NOTAS KAFFOL



UDS	PRECIO	IMPRESIÓN	SUBTOTAL	IVA 21%	TOTAL
100 uds	2.23€/ud	P 0.20€/ud G 0.60€/ud	2.43€/ud 2.83€/ud	0.51€ 0.59€	2.94€/ud 3.42€/ud
200 uds	2.23€/ud	P 0.15€/ud G 0.50€/ud	2.38€/ud 2.73€/ud	0.50€ 0.57€	2.88€/ud 3.30€/ud
500 uds	2.18€/ud	P 0.14€/ud G 0.40€/ud	2.32€/ud 2.58€/ud	0.49€ 0.54€	2.81€/ud 3.12€/ud
1000 uds	2.18€/ud	P 0.14€/ud G 0.40€/ud	2.32€/ud 2.58€/ud	0.49€ 0.54€	2.81€/ud 3.12€/ud



Área Grande



Área Pequeña

+ Barniz UVI - P 0.20€/ud
G 0.50€/ud

+ Tinta Blanca - P 0.20€/ud
G 0.50€/ud

Hora de diseño/maquetación personalizado 28€/h

No incluye instalación - No incluyen elementos de sujeción

08 MERCHANDISING

IMPRESIÓN SOBRE RÍGIDOS

MERCHANDISING 08

IMPRESIÓN SOBRE RÍGIDOS

PUESTA EN MARCHA 24.80€ +iva

BOLÍGRAFO UNIVERSAL	UDS	PRECIO	IMPRESIÓN	SUBTOTAL	IVA 21%	TOTAL
	100 uds	0.20€/ud	0.25€/ud	0.45€/ud	0.09€	0.55€/ud
	200 uds	0.20€/ud	0.20€/ud	0.40€/ud	0.08€	0.48€/ud
	500 uds	0.18€/ud	0.12€/ud	0.30€/ud	0.06€	0.36€/ud
	1000 uds	0.18€/ud	0.10€/ud	0.28€/ud	0.05€	0.33€/ud
	5000 uds	0.17€/ud	0.10€/ud	0.27€/ud	0.05€	0.32€/ud



+ Barniz UVI 0.05€/ud + Tinta Blanca 0.05€/ud

JARRA NAIMEL	UDS	PRECIO	IMPRESIÓN	SUBTOTAL	IVA 21%	TOTAL
	1ud	3.00€/ud	0.80€/ud	3.80€/ud	0.80€	4.60€/ud
	100 uds	2.60€/ud	0.80€/ud	3.40€/ud	0.71€	4.11€/ud
	500 uds	2.50€/ud	0.50€/ud	3.00€/ud	0.63€	3.63€/ud
	1000 uds	2.50€/ud	0.50€/ud	3.00€/ud	0.63€	3.63€/ud



+ Barniz UVI 0.50€/ud + Tinta Blanca 0.50€/ud

Hora de diseño/maquetación personalizado

28€/h

No incluye instalación - No incluyen elementos de sujeción

PUESTA EN MARCHA 24.80€ +iva

CRISTAL NELUM 140mm	UDS	PRECIO	IMPRESIÓN	SUBTOTAL	IVA 21%	TOTAL
Estuche incluido	1ud	5.20€/ud	30.00€/ud	35.20€/ud	7.39€	42.59€/ud
	100 uds	5.20€/ud	2.40€/ud	7.60€/ud	1.59€	9.19€/ud
	500 uds	4.90€/ud	2.30€/ud	7.20€/ud	1.51€	8.71€/ud



Área Grabación Láser



Área Impresión Color



Grabación Láser



Impresión Full color

+ Barniz UVI 0.50€/ud + Tinta Blanca 0.50€/ud

FUNDA DE MÓVIL	UDS	IMPRESIÓN	IVA 21%	TOTAL
	1ud	7.90€/ud	1.65€	9.55€/ud
	5 uds	6.90€/ud	1.44€	8.34€/ud
	10 uds	4.90€/ud	1.02€	5.92€/ud
	+ de 20 uds	3.90€/ud	0.81€	4.71€/ud



Impresión Full color



Área Impresión

+ Barniz UVI 0.50€/ud + Tinta Blanca 0.50€/ud

Hora de diseño/maquetación personalizado

28€/h

No incluye instalación - No incluyen elementos de sujeción

08 MERCHANDISING

IMPRESIÓN SOBRE RÍGIDOS

PINES METÁLICOS

DISEÑO y MOLDE 60.00€ +iva



UDS	PRECIO	IVA 21%	TOTAL
100 uds	1.80€/ud	0.37€	2.17€/ud
300 uds	1.12€/ud	0.23€	1.35€/ud
500 uds	1.01€/ud	0.21€	1.22€/ud
1000 uds	0.90€/ud	0.18€	1.08€/ud

PUESTA EN MARCHA 24.80€ +iva

LINTERNAS



UDS	PRECIO	IMPRESIÓN	SUBTOTAL	IVA 21%	TOTAL
100 uds	0.80€/ud	0.30€/ud	1.10€/ud	0.23€	1.31€/ud
200 uds	0.80€/ud	0.27€/ud	1.07€/ud	0.22€	1.29€/ud
500 uds	0.60€/ud	0.25€/ud	0.85€/ud	0.17€	1.02€/ud
1000 uds	0.50€/ud	0.20€/ud	0.70€/ud	0.14€	0.84€/ud

+ Barniz UVI 0.10€/ud + Tinta Blanca 0.10€/ud



Hora de diseño/maquetación personalizado

28€/h

MERCHANDISING 08

IMPRESIÓN SOBRE RÍGIDOS

PUESTA EN MARCHA 24.80€ +iva

LLAVERO YIP



UDS	PRECIO	IMPRESIÓN	SUBTOTAL	IVA 21%	TOTAL
100 uds	0.66€/ud	1 Cara 0.30€/ud	0.96€/ud	0.20€	1.16€/ud
		2C 0.50€/ud	1.16€/ud	0.24€	1.40€/ud
200 uds	0.66€/ud	1C 0.27€/ud	0.93€/ud	0.20€	1.13€/ud
		2C 0.45€/ud	1.11€/ud	0.23€	1.34€/ud
500 uds	0.62€/ud	1C 0.25€/ud	0.87€/ud	0.18€	1.05€/ud
		2C 0.40€/ud	1.02€/ud	0.21€	1.23€/ud
1000 uds	0.60€/ud	1C 0.20€/ud	0.80€/ud	0.17€	0.97€/ud
		2C 0.30€/ud	0.90€/ud	0.19€	1.09€/ud

+ Barniz UVI 0.10€/ud + Tinta Blanca 0.10€/ud

VASO HECOX



UDS	PRECIO	IMPRESIÓN	SUBTOTAL	IVA 21%	TOTAL
100 uds	0.20€/ud	0.45€/ud	0.65€/ud	0.13€	0.78€/ud
500 uds	0.20€/ud	0.26€/ud	0.46€/ud	0.09€	0.55€/ud
1000 uds	0.20€/ud	0.20€/ud	0.40€/ud	0.08€	0.48€/ud
5000 uds	0.18€/ud	0.12€/ud	0.30€/ud	0.06€	0.36€/ud



Hora de diseño/maquetación personalizado

28€/h

08 MERCHANDISING

IMPRESIÓN SOBRE RÍGIDOS

PUESTA EN MARCHA 24.80€ +iva

ENCENDEDOR FENICK	UDS	PRECIO	IMPRESIÓN 1 Cara/2 Caras	SUBTOTAL	IVA21%	TOTAL
	100 uds	0.20€/ud	1C 0.40€/ud	0.60€/ud	0.12€	0.72€/ud
			2C 0.70€/ud	0.90€/ud	0.18€	1.08€/ud
	200 uds	0.20€/ud	1C 0.25€/ud	0.45€/ud	0.09€	0.54€/ud
			2C 0.40€/ud	0.60€/ud	0.12€	0.73€/ud
	500 uds	0.19€/ud	1C 0.19€/ud	0.38€/ud	0.07€	0.45€/ud
			2C 0.28€/ud	0.47€/ud	0.09€	0.56€/ud
	1000 uds	0.19€/ud	1C 0.15€/ud	0.34€/ud	0.07€	0.41€/ud
			2C 0.20€/ud	0.39€/ud	0.08€	0.47€/ud



Área Impresión
a 1 Cara o a 2 caras

+ Barniz UVI 0.10€/ud

+ Tinta Blanca 0.10€/ud

TAZAS



Hora de diseño/maquetación personalizado

28€/h

No incluye instalación - No incluyen elementos de sujeción

MERCHANDISING 08

IMPRESIÓN SOBRE RÍGIDOS

PUESTA EN MARCHA 24.80€ +iva

USB REBIK 16Gb	UDS	PRECIO	IMPRESIÓN 1 Cara/2 Caras	SUBTOTAL	IVA21%	TOTAL
	100 uds	3.08€/ud	1C 0.40€/ud	3.48€/ud	0.73€	4.21€/ud
			2C 0.60€/ud	3.68€/ud	0.77€	4.45€/ud
	200 uds	3.08€/ud	1C 0.28€/ud	3.36€/ud	0.70€	4.06€/ud
			2C 0.50€/ud	3.58€/ud	0.75€	4.33€/ud
	500 uds	3.08€/ud	1C 0.18€/ud	3.26€/ud	0.68€	3.94€/ud
			2C 0.30€/ud	3.38€/ud	0.70€	4.08€/ud
	1000 uds	3.08€/ud	1C 0.15€/ud	3.23€/ud	0.67€	3.90€/ud
			2C 0.25€/ud	3.33€/ud	0.69€	4.02€/ud



Área Impresión
a 1 Cara o a 2 caras

+ Barniz UVI 0.10€/ud

+ Tinta Blanca 0.10€/ud

ORDENADOR PORTATIL



+ Barniz UVI 0.10€/ud

+ Tinta Blanca 0.10€/ud

Hora de diseño/maquetación personalizado

28€/h

No incluye instalación - No incluyen elementos de sujeción

08 MERCHANDISING

IMPRESIÓN SOBRE RÍGIDOS

MERCHANDISING 08

IMPRESIÓN SOBRE RÍGIDOS

PELOTA DE GOLF



PUESTA EN MARCHA

15.00€
Hasta 500 uds
+500 uds
+2000 uds
+5000 uds

+ Barniz UVI

IMPRESIÓN

15.00€/ud
1.08€/ud
1.04€/ud
0.99€/ud
0.95€/ud

1.00€/ud

PIEL



UDS	PRECIO	IMPRESIÓN 1 Cara/2 Caras	SUBTOTAL	IVA 21%	TOTAL
1ud	0.90€/ud	1C 30.00€/ud 2C 50.00€/ud	30.90€/ud 50.90€/ud	6.48€ 10.68€	37.38€/ud 61.58€/ud
100 uds	0.90€/ud	1C 0.90€/ud 2C 1.60€/ud	1.80€/ud 2.50€/ud	0.37€ 0.52€	2.17€/ud 3.02€/ud
200 uds	0.85€/ud	1C 0.80€/ud 2C 1.40€/ud	1.65€/ud 2.25€/ud	0.34€ 0.47€	1.99€/ud 2.72€/ud
500 uds	0.80€/ud	1C 0.60€/ud 2C 1.00€/ud	1.40€/ud 1.80€/ud	0.29€ 0.37€	1.69€/ud 2.17€/ud

+ Barniz UVI 0.10€/ud

+ Tinta Blanca 0.10€/ud

Hora de diseño/maquetación personalizado

28€/h

PLACA IDENTIFICATIVA INTERCAMBIABLE



UDS IMPRESIÓN IVA 21% TOTAL

Hasta 10 uds	6.50€/ud	1.36€	7.86€/ud
+25 uds	5.50€/ud	1.15€	6.65€/ud
+50 uds	5.00€/ud	1.05€	6.05€/ud
+100 uds	4.00€/ud	0.84€	4.84€/ud
+ Barniz UVI	3.50€/ud	0.73€	4.23€/ud

POWER BANK



UDS	PRECIO	IMPRESIÓN	SUBTOTAL	IVA 21%	TOTAL
1ud	15.80€/ud	30.00€/ud	45.80€/ud	9.61€	55.41€/ud
100 uds	15.80€/ud	0.60€/ud	16.40€/ud	3.44€	19.84€/ud
200 uds	14.80€/ud	0.50€/ud	15.30€/ud	3.21€	18.51€/ud
500 uds	12.90€/ud	0.40€/ud	13.30€/ud	2.97€	16.09€/ud

+ Barniz UVI 0.10€/ud

+ Tinta Blanca 0.10€/ud

Hora de diseño/maquetación personalizado

28€/h

08 MERCHANDISING

IMPRESIÓN SOBRE RÍGIDOS

PUESTA EN MARCHA 24.80€ +iva

BOLSAS DE PAPEL

25X31X11cm



UDS	PRECIO	IMPRESIÓN	SUBTOTAL	IVA 21%	TOTAL
100uds	0.22€/ud	1C 0.80€/ud	1.02€/ud	0.21€	1.23€/ud
		2C 1.50€/ud	1.72€/ud	0.36€	2.08€/ud
200 uds	0.22€/ud	1C 0.56€/ud	1.80€/ud	0.37€	2.17€/ud
		2C 1.02€/ud	1.24€/ud	0.26€	1.50€/ud
500 uds	0.21€/ud	1C 0.50€/ud	0.71€/ud	0.14€	0.85€/ud
		2C 1.11€/ud	1.32€/ud	0.27€	1.59€/ud
1000 uds	0.21€/ud	1C 0.50€/ud	0.71€/ud	0.14€	0.85€/ud
		2C 1.11€/ud	1.32€/ud	0.27€	1.59€/ud
2000 uds	0.20€/ud	1C 0.40€/ud	0.60€/ud	0.12€	0.72€/ud
		2C 0.75€/ud	0.95€/ud	0.19€	1.14€/ud

BOLSAS DE PAPEL

30X40X11cm



UDS	PRECIO	IMPRESIÓN	SUBTOTAL	IVA 21%	TOTAL
100uds	0.22€/ud	1C 0.80€/ud	1.02€/ud	0.21€	1.23€/ud
		2C 1.50€/ud	1.72€/ud	0.36€	2.08€/ud
200 uds	0.22€/ud	1C 0.56€/ud	1.80€/ud	0.37€	2.17€/ud
		2C 1.02€/ud	1.24€/ud	0.26€	1.50€/ud
500 uds	0.21€/ud	1C 0.50€/ud	0.71€/ud	0.14€	0.85€/ud
		2C 1.11€/ud	1.32€/ud	0.27€	1.59€/ud
1000 uds	0.21€/ud	1C 0.50€/ud	0.71€/ud	0.14€	0.85€/ud
		2C 1.11€/ud	1.32€/ud	0.27€	1.59€/ud
2000 uds	0.20€/ud	1C 0.40€/ud	0.60€/ud	0.12€	0.72€/ud
		2C 0.75€/ud	0.95€/ud	0.19€	1.14€/ud

Hora de diseño/maquetación personalizado

28€/h

No incluye instalación - No incluyen elementos de sujeción

MERCHANDISING 08

IMPRESIÓN SOBRE RÍGIDOS

PUESTA EN MARCHA 24.80€ +iva

TARJETERO RFID



Impresión Full color

UDS	PRECIO	IMPRESIÓN	SUBTOTAL	IVA 21%	TOTAL
100uds	0.92€/ud	0.40€/ud	1.32€/ud	0.27€	1.59€/ud
300 uds	0.90€/ud	0.34€/ud	1.24€/ud	0.26€	1.50€/ud
500 uds	0.90€/ud	0.25€/ud	1.15€/ud	0.24€	1.39€/ud
1000 uds	0.90€/ud	0.20€/ud	1.10€/ud	0.23€	1.33€/ud

PUESTA EN MARCHA 24.80€ +iva

POSAVASOS BRUNEX



Impresión Full color

UDS	PRECIO	IMPRESIÓN	SUBTOTAL	IVA 21%	TOTAL
100uds	0.20€/ud	0.40€/ud	0.60€/ud	0.12€	0.72€/ud
200 uds	0.20€/ud	0.34€/ud	0.54€/ud	0.11€	0.65€/ud
500 uds	0.19€/ud	0.28€/ud	0.47€/ud	0.09€	0.56€/ud
1000 uds	0.19€/ud	0.28€/ud	0.47€/ud	0.09€	0.56€/ud
5000 uds	0.18€/ud	0.20€/ud	0.38€/ud	0.07€	0.45€/ud
10000 uds	0.18€/ud	0.20€/ud	0.38€/ud	0.07€	0.45€/ud

Hora de diseño/maquetación personalizado

28€/h

No incluye instalación - No incluyen elementos de sujeción

08 MERCHANDISING

IMPRESIÓN SOBRE RÍGIDOS

GRABACIÓN LÁSER

ALFOMBRILLA GONG UDS PRECIO IMPRESIÓN SUBTOTAL IVA 21% TOTAL



100uds	2.58€/ud	0.40€/ud	2.98€/ud	0.62€	3.60€/ud
300 uds	2.58€/ud	0.40€/ud	2.98€/ud	0.62€	3.60€/ud
500 uds	2.53€/ud	0.35€/ud	2.88€/ud	0.60€	3.48€/ud
1000 uds	2.53€/ud	0.35€/ud	2.88€/ud	0.60€	3.48€/ud
5000 uds	2.40€/ud	0.25€/ud	2.65€/ud	0.55€	3.20€/ud
10000 uds	2.40€/ud	0.25€/ud	2.65€/ud	0.55€	3.20€/ud

PUESTA EN MARCHA 24.80€ +iva

ALFOMBRILLA GONG UDS PRECIO IMPRESIÓN SUBTOTAL IVA 21% TOTAL



100uds	2.58€/ud	0.30€/ud	2.88€/ud	0.60€	3.48€/ud
300 uds	2.58€/ud	0.30€/ud	2.88€/ud	0.60€	3.48€/ud
500 uds	2.53€/ud	0.28€/ud	2.81€/ud	0.59€	3.40€/ud
1000 uds	2.53€/ud	0.25€/ud	2.78€/ud	0.58€	3.36€/ud
5000 uds	2.40€/ud	0.20€/ud	2.60€/ud	0.54€	3.14€/ud
10000 uds	2.40€/ud	0.20€/ud	2.60€/ud	0.54€	3.14 €/ud

MERCHANDISING 08

IMPRESIÓN SOBRE RÍGIDOS

PUESTA EN MARCHA 24.80€ +iva

ALFOMBRILLA SERFAT UDS PRECIO IMPRESIÓN SUBTOTAL IVA 21% TOTAL



100uds	0.42€/ud	0.97€/ud	1.39€/ud	0.29€	1.68€/ud
300 uds	0.42€/ud	0.77€/ud	1.19€/ud	0.24€	1.43€/ud
500 uds	0.40€/ud	0.69€/ud	1.09€/ud	0.22€	1.31€/ud
1000 uds	0.40€/ud	0.69€/ud	1.09€/ud	0.22€	1.31€/ud
5000 uds	0.38€/ud	0.69€/ud	1.07€/ud	0.22€	1.29€/ud
10000 uds	0.38€/ud	0.69€/ud	1.07€/ud	0.22€	1.29€/ud

SUBLIMACIÓN A TODO COLOR

ALFOMBRILLA VANIAT UDS PRECIO IMPRESIÓN SUBTOTAL IVA 21% TOTAL



100uds	0.28€/ud	0.97€/ud	1.25€/ud	0.26€	1.51€/ud
300 uds	0.27€/ud	0.77€/ud	1.04€/ud	0.21€	1.25€/ud
500 uds	0.27€/ud	0.69€/ud	0.96€/ud	0.20€	1.16€/ud
1000 uds	0.27€/ud	0.69€/ud	0.96€/ud	0.20€	1.16€/ud
5000 uds	0.25€/ud	0.69€/ud	0.94€/ud	0.19€	1.13€/ud
10000 uds	0.25€/ud	0.69€/ud	0.94€/ud	0.19€	1.13€/ud

08 MERCHANDISING

IMPRESIÓN SOBRE RÍGIDOS

MERCHANDISING 08

IMPRESIÓN SOBRE RÍGIDOS

IMPRESIÓN A TODO COLOR

**PORTANOTAS
CALENDARIO NUFET**



UDS	PRECIO	IMPRESIÓN	PUESTA EN MARCHA 24.80€+iva		
			SUBTOTAL	IVA 21%	TOTAL
100uds	0.99€/ud	0.50€/ud	1.49€/ud	0.31€	1.80€/ud
300 uds	0.98€/ud	0.45€/ud	1.43€/ud	0.30€	1.73€/ud
500 uds	0.90€/ud	0.40€/ud	1.30€/ud	0.27€	1.57€/ud
1000 uds	0.80€/ud	0.35€/ud	1.15€/ud	0.24€	1.39€/ud
5000 uds	0.75€/ud	0.30€/ud	1.05€/ud	0.22€	1.27€/ud

GRABACIÓN LÁSER

**PORTANOTAS
CALENDARIO NUFET**



UDS	PRECIO	IMPRESIÓN	PUESTA EN MARCHA 24.80€+iva		
			SUBTOTAL	IVA 21%	TOTAL
100uds	0.99€/ud	0.40€/ud	1.39€/ud	0.29€	1.68€/ud
300 uds	0.98€/ud	0.40€/ud	1.38€/ud	0.28€	1.66€/ud
500 uds	0.90€/ud	0.35€/ud	1.25€/ud	0.26€	1.51€/ud
1000 uds	0.80€/ud	0.35€/ud	1.15€/ud	0.24€	1.39€/ud
5000 uds	0.75€/ud	0.30€/ud	1.05€/ud	0.22€	1.27/ud



Impresión
Full color



Grabación
Láser

09 CALENDARIOS

CALENDARIOS 09

IMPRESIÓN A TODO COLOR

CALENDARIO FEBER

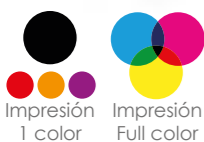

UDS	PRECIO	IMPRESIÓN	PUESTA EN MARCHA 24.80€+iva		
			SUBTOTAL	IVA 21%	TOTAL
100uds	0.42€/ud	1C 0.50€/ud	0.92€/ud	0.19€	1.11€/ud
		TC 1.50€/ud	1.92€/ud	0.40€	2.32€/ud
500 uds	0.40€/ud	1C 0.30€/ud	0.70€/ud	0.14€	0.84€/ud
		TC 1.28€/ud	1.68€/ud	0.35€	2.03€/ud
1000 uds	0.40€/ud	1C 0.20€/ud	0.60€/ud	0.12€	0.72€/ud
		TC 0.90€/ud	1.30€/ud	0.27€	1.57€/ud
5000 uds	0.39€/ud	1C 0.20€/ud	0.59€/ud	0.12€	0.71€/ud
		TC 0.65€/ud	1.04€/ud	0.21€	1.25€/ud

CALENDARIO GLASS PACK



UDS	PRECIO	IVA 21%	PUESTA EN MARCHA 24.80€ +iva	
			SUBTOTAL	TOTAL
A5 210x148mm	1ud	15.00€/ud	3.15€	18.15€/ud
	100 uds	3.50€/ud	0.73€	4.23€/ud
	500 uds	2.80€/ud	0.58€	3.38€/ud
	1000 uds	2.00€/ud	0.42€	2.42€/ud
A4 210x297mm	1ud	20.00€/ud	4.20€	24.20€/ud
	100 uds	3.90€/ud	0.81€	4.71€/ud
	500 uds	3.10€/ud	0.65€	3.75€/ud
	1000 uds	2.60€/ud	0.54€	3.14€/ud
A3 297x420mm	1ud	25.00€/ud	5.25€	30.25€/ud
	100 uds	4.90€/ud	1.02€	5.92€/ud
	500 uds	4.10€/ud	0.86€	4.96€/ud
	1000 uds	3.60€/ud	0.75€	4.35€/ud

IMPRESIÓN A TODO COLOR

CALENDARIO FALDILLA PAPEL



UDS	PRECIO	PAPEL A4	SOPORTE SUJECCIÓN	PUESTA EN MARCHA 24.80€+iva		
				SUBTOTAL	IVA 21%	TOTAL
100uds	0.90€/ud	0.60€/ud	0.50€/ud	1.46€/ud	0.30€	1.76€/ud
300 uds	0.85€/ud	0.58€/ud	0.40€/ud	1.83€/ud	0.38€	2.21€/ud
500 uds	0.80€/ud	0.45€/ud	0.20€/ud	1.45€/ud	0.30€	1.75€/ud
1000 uds	0.75€/ud	0.30€/ud	0.20€/ud	1.25€/ud	0.26€	1.51€/ud

IMPRESIÓN A TODO COLOR

CALENDARIO FALDILLA GLASS PACK



UDS	PRECIO	IVA 21%	TOTAL
100uds	2.30€/ud	0.48€	2.78€/ud
300 uds	2.20€/ud	0.46€	2.66€/ud
500 uds	1.90€/ud	0.39€	2.29€/ud
1000 uds	1.50€/ud	0.31€	1.81€/ud

10 PLACAS HOMENAJE



PLACAS HOMENAJE 10

PERGAMINO FINO



TAMAÑO	PRECIO	IVA 21%	PVP
--------	--------	---------	-----

Gr 210 x 290mm	58.00€/ud	12.18€	70.18€/ud
Md 190 x 250mm	48.00€/ud	10.08€	58.08€/ud
Pq 150 x 190mm	30.00€/ud	6.30€	36.30€/ud

+ Madera y estuche Gr de Lujo 18.00€/ud 3.78€ 21.78€/ud

+ Madera y estuche Md de Lujo 15.00€/ud 3.15€ 18.15€/ud

PERGAMINO GR



PRECIO	IVA 21%	PVP
--------	---------	-----

Gr 210 x 290mm	58.00€/ud	12.18€	70.18€/ud
Md 190 x 250mm	48.00€/ud	10.08€	58.08€/ud
Pq 150 x 190mm	30.00€/ud	6.30€	36.30€/ud

+ Madera y estuche Gr de Lujo 18.00€/ud 3.78€ 21.78€/ud

+ Madera y estuche Md de Lujo 15.00€/ud 3.15€ 18.15€/ud

10 PLACAS HOMENAJE

PLACA HOMENAJE RAYOS

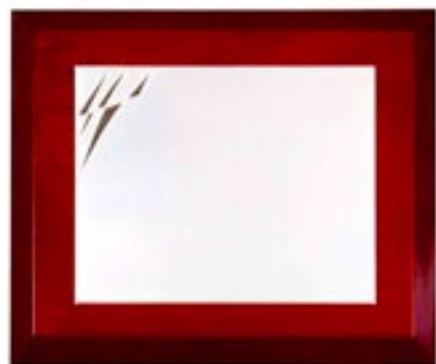

TAMAÑO	PRECIO	IVA 21%	PVP
Gr 210 x 290mm	45.00€/ud	9.45€	54.45€/ud
Md 190 x 250mm	35.00€/ud	7.35€	42.35€/ud
Pq 100 x 150mm	25.00€/ud	5.25€	30.25€/ud
+ Madera y estuche Gr de Lujo	18.00€/ud	3.78€	21.78€/ud
+ Madera y estuche Md de Lujo	15.00€/ud	3.15€	18.15€/ud



PLACA HOMENAJE PLIX

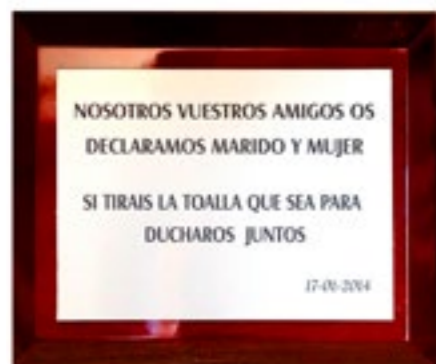

TAMAÑO	PRECIO	IVA 21%	PVP
Gr 210 x 290mm	45.00€/ud	9.45€	54.45€/ud
Md 190 x 250mm	35.00€/ud	7.35€	42.35€/ud
Pq 150 x 190mm	25.00€/ud	5.25€	30.25€/ud
+ Madera y estuche Gr de Lujo	18.00€/ud	3.78€	21.78€/ud
+ Madera y estuche Md de Lujo	15.00€/ud	3.15€	18.15€/ud



PLACAS HOMENAJE 10

PERGAMINO DIAMANTE



TAMAÑO	PRECIO	IVA 21%	PVP
Gr 210 x 290mm	45.00€/ud	9.45€	54.45€/ud
Md 190 x 250mm	35.00€/ud	7.35€	42.35€/ud
Pq 150 x 190mm	25.00€/ud	5.25€	30.25€/ud
+ Madera y estuche Gr de Lujo	18.00€/ud	3.78€	21.78€/ud
+ Madera y estuche Md de Lujo	15.00€/ud	3.15€	18.15€/ud



PERGAMINO AZUL



TAMAÑO	PRECIO	IVA 21%	PVP
Gr 210 x 290mm	68.00€/ud	14.28€	82.28€/ud
+ Madera y estuche Gr de Lujo	18.00€/ud	3.78€	21.78€/ud
+ Madera y estuche Md de Lujo	15.00€/ud	3.15€	18.15€/ud



10 PLACAS HOMENAJE

PLACAS HOMENAJE 10

PLATO



TAMAÑO	PRECIO	IVA 21%	PVP
280mm de Diámetro	90.00/ud	18.90€	108.90€/ud

BORDE FINO



	PRECIO	IVA 21%	PVP
Gr 230 x 180mm	78.00€/ud	16.38€	94.38€/ud
Md 200 x 150mm	68.00€/ud	14.28€	82.28€/ud
Pq 160 x 120mm	48.00€/ud	10.08€	58.08€/ud
+ Madera y estuche Gr de Lujo	18.00€/ud	3.78€	21.78€/ud
+ Madera y estuche Md de Lujo	15.00€/ud	3.15€	18.15€/ud

ESQUINAS REDONDEADAS



TAMAÑO	PRECIO	IVA 21%	PVP
Gr 230 x 180mm	78.00€/ud	16.38€	94.38€/ud
Md 200 x 150mm	68.00€/ud	14.28€	82.28€/ud
+ Madera y estuche Gr de Lujo	18.00€/ud	3.78€	21.78€/ud
+ Madera y estuche Md de Lujo	15.00€/ud	3.15€	18.15€/ud

ALPACA BAÑO DE PLATA



	PRECIO	IVA 21%	PVP
Gr 230 x 180mm	140.00€/ud	29.40€	169.40€/ud
Md 200 x 150mm	118.00€/ud	24.78€	142.78€/ud
+ Madera y estuche Gr de Lujo	18.00€/ud	3.78€	21.78€/ud
+ Madera y estuche Md de Lujo	15.00€/ud	3.15€	18.15€/ud

10 PLACAS HOMENAJE

MADERA & ESTUCHE



MEDIDAS	PRECIO	IVA 21%	PVP
Estuche 350 x 280 x 45mm Madera 290 x 230mm	12.00€/ud	2.52€	14.52€/ud
Estuche 300 x 240 x 45mm Madera 240 x 190mm	10.00€/ud	2.10€	12.10€/ud

MADERA & ESTUCHE LUJO



MEDIDAS	PRECIO	IVA 21%	PVP
Estuche 350 x 280 x 45mm Madera 290 x 230mm	18.00€/ud	3.78€	21.78€/ud
Estuche 300 x 240 x 45mm Madera 240 x 190mm	15.00€/ud	3.15€	18.15€/ud

No incluye instalación - No incluyen elementos de sujección

TROFEOS 11

TEMÁTICAS

Académica
Baloncesto
Balonmano
Carnaval
Caza
Ciclismo
Colombicultura
Cristal
Cuerpos del Estado
Deportes Varios
Fútbol
Gastronomía
Golf
Hípica
Artes Marciales
Juegos de Azar
Literatura y Arte
Motor
Música
Pádel
Religioso



11 TROFEOS

TROFEOS 11

COPAS



JOSE LOPEZ LOPEZ
CAMPEÓN
CAMPEONATO DE FUTBOL

Ejemplo de grabación
en Plix Plateado



UDS	PRECIO	IMPRESIÓN	SUBTOTAL	IVA 21%	TOTAL
1ud	10.00€/ud	3.00€/ud	13.00€/ud	2.73€	15.73€/ud
10 uds	9.00€/ud	2.45€/ud	11.45€/ud	2.40€	13.85€/ud
50 uds	8.00€/ud	0.00€/ud	8.00€/ud	1.68€	9.68€/ud
100 uds	7.00€/ud	0.00€/ud	7.00€/ud	1.47€	8.47€/ud

MEDALLAS



ORO



PLATA



BRONCE



TAMAÑOS

60mm
+ Grabación y cinta

50mm
+ Grabación y cinta

60mm
Sin Grabación y cinta

50mm
+ Grabación y cinta

PRECIO

1 unidad 6.00€ +iva
1 a 10 uds 3.50€/ud +iva
10 a 50 uds 2.90€/ud +iva
50 a 100 uds 2.50€/ud +iva
500 a 100 uds 2.10€/ud +iva
+ de 500 uds 1.55€/ud +iva

1 unidad 5.00€ +iva
1 a 10 uds 3.25€/ud +iva
10 a 50 uds 2.75€/ud +iva
50 a 100 uds 2.20€/ud +iva
500 a 100 uds 1.75€/ud +iva
+ de 500 uds 0.99€/ud +iva

1 unidad 3.00€ +iva
1 a 10 uds 2.50€/ud +iva
10 a 100 uds 2.00€/ud +iva
+ de 100 uds 1.70€/ud +iva
+ de 500 uds 1.35€/ud +iva

1 unidad 3.00€ +iva
1 a 10 uds 2.50€/ud +iva
10 a 100 uds 2.00€/ud +iva
+ de 100 uds 1.50€/ud +iva
+ de 500 uds 1.35€/ud +iva

11 TROFEOS

TROFEOS 11

FIGURAS



UDS	PRECIO	IMPRESIÓN	SUBTOTAL	IVA 21%	TOTAL
1ud	10.00€/ud	3.00€/ud	13.00€/ud	2.73€	15.73€/ud
10 uds	9.00€/ud	2.45€/ud	11.45€/ud	2.40€	13.85€/ud
50 uds	8.00€/ud	0.00€/ud	8.00€/ud	1.68€	9.68€/ud
100 uds	7.00€/ud	0.00€/ud	7.00€/ud	1.47€	8.47€/ud

UDS	PRECIO	IMPRESIÓN	SUBTOTAL	IVA 21%	TOTAL
1ud	10.00€/ud	3.00€/ud	13.00€/ud	2.73€	15.73€/ud
10 uds	9.00€/ud	2.45€/ud	11.45€/ud	2.40€	13.85€/ud
50 uds	8.00€/ud	0.00€/ud	8.00€/ud	1.68€	9.68€/ud
100 uds	7.00€/ud	0.00€/ud	7.00€/ud	1.47€	8.47€/ud

CRISTAL



TAMAÑOS

TAMAÑOS	PRECIO	IVA 21%	PVP
120 x 120mm	30.00€/ud	6.30€	36.30€/ud
140 x 140mm	40.00€/ud	8.40€	48.40€/ud
160 x 160mm	50.00€/ud	10.50€	60.50€/ud
200 x 200mm	60.00€/ud	12.60€	72.60€/ud

Incluye Estuche

BOLQUE DE CRISTAL



MEDIDAS

MEDIDAS	UDS	PRECIO	IVA 21%	TOTAL
150 x 200 x 20mm	1ud	35.00€/ud	7.35€	42.35€/ud
	Más de 10 uds	30.00€/ud	6.30€	36.30€/ud
	Más de 25 uds	28.00€/ud	5.88€	33.88€/ud
150 x 200 x 25mm	1ud	45.00€/ud	9.45€	54.45€/ud
	Más de 10 uds	40.00€/ud	8.40€	48.40€/ud
	Más de 25 uds	38.00€/ud	7.98€	45.98€/ud

Incluye Estuche

11 TROFEOS GRABACIÓN

GRABACIONES 12

METACRILATO PERSONALIZADO



TAMAÑOS PRECIO IVA 21% PVP

Hasta 10cm de altura

1 ud	40.00€/ud	8.40€	48.40€/ud
5 uds	16.00€/ud	3.36€	19.36€/ud
10 uds	12.00€/ud	2.52€	14.52€/ud
20 uds	9.00€/ud	1.89€	10.89€/ud
50 uds	5.50€/ud	1.15€	6.65€/ud

De 10 a 20cm de altura

1 ud	45.00€/ud	9.45€	54.45€/ud
5 uds	24.00€/ud	5.04€	29.04€/ud
10 uds	18.00€/ud	3.78€	21.78€/ud
20 uds	15.00€/ud	3.15€	18.15€/ud
50 uds	9.50€/ud	1.99€	11.49€/ud

De 20 a 30cm de altura

1 ud	70.00€/ud	14.70€	84.70€/ud
5 uds	55.00€/ud	11.55€	66.55€/ud
10 uds	45.00€/ud	9.45€	54.45€/ud
20 uds	35.00€/ud	7.35€	42.35€/ud
50 uds	29.00€/ud	6.09€	35.09€/ud

GRABACIÓN PLACAS BUZÓN



PLACAS IDENTIFICATIVAS



Precio X Ancho de placa
Mínimo 10.00€

UDS	PRECIO	IVA 21%	TOTAL
1 ud	10.00€/ud	2.10€	12.10€/ud
+ de 10 uds	5.00€/ud	1.05€	6.05€/ud
+ de 20 uds	3.50€/ud	0.73€	4.23€/ud

UDS	PRECIO	IVA 21%	TOTAL
1 ud	12.00€/ud	2.52€	14.52€/ud
+ de 10 uds	8.00€/ud	1.68€	9.68€/ud
+ de 20 uds	5.50€/ud	1.15€	6.65€/ud

METACRILATO

1 ud	14.00€/ud	2.94€	16.94€/ud
+ de 10 uds	9.00€/ud	1.89€	10.89€/ud
+ de 20 uds	5.65€/ud	1.18€	6.83€/ud

INTERCALADO

1 ud	6.00€/ud	1.26€	7.26€/ud
+ de 10 uds	4.00€/ud	0.84€	4.84€/ud
+ de 20 uds	3.50€/ud	0.73€	4.23€/ud

13 SELLOS



AUTOMÁTICOS SELLOS 13

RECTANGULAR

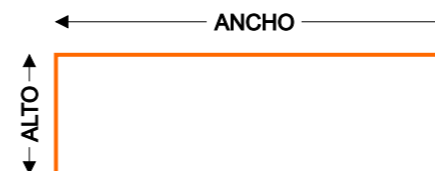

MOD	ALT x ANCHO	PRECIO	IVA 21%	PVP
Printy	18 x 47mm	12.40€/ud	2.60€	15.00€/ud
4911	14 x 38mm	17.62€/ud	3.70€	21.32€/ud
4912	18 x 47mm	19.33€/ud	4.05€	23.38€/ud
4913	22 x 58mm	21.34€/ud	4.48€	25.82€/ud
4914	26 x 64mm	26.11€/ud	5.48€	31.59€/ud
4915	25 x 70mm	25.90€/ud	5.43€	31.33€/ud
4926	38 x 75mm	28.33€/ud	5.94€	34.27€/ud
4927	40 x 60mm	27.82€/ud	5.84€	33.66€/ud
4928	33 x 60mm	25.63€/ud	5.38€	31.01€/ud
4931	30 x 70mm	26.02€/ud	5.46€	31.48€/ud
4926	38 x 75mm	19.33€/ud	4.05€	23.38€/ud
4927	40 x 60mm	21.34€/ud	4.48€	25.82€/ud
4928	33 x 60mm	26.11€/ud	5.48€	31.59€/ud
4941	24 x 41mm	21.67€/ud	4.55€	26.22€/ud

CUADRADO

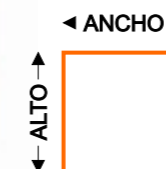

MOD	ALT x ANCHO	PRECIO	IVA 21%	PVP
4921	12 x 12mm	16.87€/ud	3.54€	20.41€/ud
4922	20 x 20mm	19.27€/ud	4.04€	23.31€/ud
4923	30 x 30mm	21.22€/ud	4.45€	25.67€/ud
4924	40 x 40mm	26.68€/ud	5.60€	32.28€/ud

13 SELLOS AUTOMÁTICOS

GAMA PROFESIONAL SELLOS 13

CIRCUNFERENCIA



MOD	DIAMETRO	PRECIO	IVA 21%	PVP
46030	30 mm Ø	23.64€/ud	4.96€	28.60€/ud
46040	40 mm Ø	26.49€/ud	5.56€	32.05€/ud
46050	50 mm Ø	29.74€/ud	6.24€	35.98€/ud

MANUAL DE MADERA



ALT x ANCHO	PRECIO	IVA 21%	PVP
22 x 58mm	15.00€/ud	3.15€	15.15€/ud
Más de 22 x 58mm	18.00€/ud	3.78€	21.78€/ud
Más de 40 x 70mm	26.00€/ud	5.46€	31.46€/ud
Circular de 30 mm Ø	15.00€/ud	3.15€	15.15€/ud
Circular de 40 mm Ø	18.00€/ud	3.78€	21.78€/ud

ALMOHADILLA DE TINTA



ALT x ANCHO	PRECIO	IVA 21%	PVP
50 x 90mm	4.09€/ud	0.85€	4.94€/ud
70 x 110mm	4.75€/ud	0.99€	5.74€/ud
90 x 130mm	7.72€/ud	1.62€	9.34€/ud

RECTANGULAR PROFESIONAL

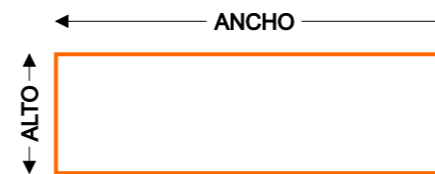

MOD	ALT x ANCHO	PRECIO	IVA 21%	PVP
5200	24 x 41mm	33.07€/ud	6.94€	40.01€/ud
5204	26 x 56mm	36.82€/ud	7.73€	44.55€/ud
5207	40 x 60mm	44.32€/ud	9.30€	53.62€/ud
5211	55 x 85mm	56.80€/ud	11.92€	68.72€/ud

FECHADOR PROFESIONAL



MOD	ALT x ANCHO	PRECIO	IVA 21%	PVP
5430	75 x 38mm	46.42€/ud	9.74€	56.16€/ud
5431	60 x 40mm	46.42€/ud	9.74€	56.16€/ud
5470	40 x 60mm	56.98€/ud	11.96€	68.94€/ud

CIRCUNFERENCIA PROFESIONAL



MOD	DIAMETRO	PRECIO	IVA 21%	PVP
52040	40 mm Ø	48.16€/ud	10.11€	58.27€/ud
5215	45 mm Ø	49.45€/ud	10.38€	59.83€/ud

FECHADOR PRO. CIRCUNFERENCIA

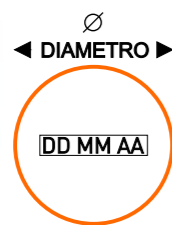

MOD	DIAMETRO	PRECIO	IVA 21%	PVP
54140	40 mm Ø	60.22€/ud	12.64€	72.86€/ud
5415	45 mm Ø	66.31€/ud	13.92€	80.23€/ud

NUMERADOR PROFESIONAL

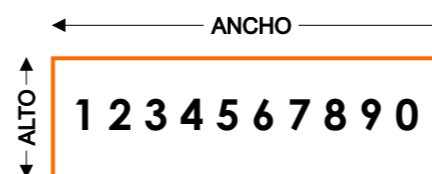

MOD	ALT x ANCHO	PRECIO	IVA 21%	PVP
5546	24 x 41mm	40.15€/ud	8.43€	48.58€/ud
55510	33 x 56mm	53.95€/ud	11.32€	65.27€/ud
55510-PL	33 x 56mm	87.76€/ud	18.42€	106.18€/ud

SELLO DE BOLSILLO

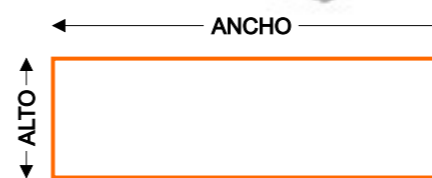

MOD	ALT x ANCHO	PRECIO	IVA 21%	PVP
9411	14 x 38mm	17.38€/ud	3.64€	21.02€/ud
9412	18 x 47mm	19.15€/ud	4.02€	23.17€/ud
9413	22 x 58mm	19.96€/ud	4.19€	24.15€/ud

13 SELLOS TIPO ESTILOGRÁFICA

SECO SELLOS 13

TIPO ESTILOGRÁFICA

AUTOMATIC



MOD	ALT x ANCHO	PRECIO	IVA 21%	PVP
302120	7 x 35mm	54.32€/ud	11.40€	65.72€/ud
302132	7 x 35mm	54.32€/ud	11.40€	65.27€/ud
302130	7 x 35mm	39.17€/ud	8.22€	47.39€/ud
302141	7 x 35mm	54.32€/ud	11.40€	65.27€/ud

GRANDOMATIC



MOD	ALT x ANCHO	PRECIO	IVA 21%	PVP
302120	7 x 35mm	64.07€/ud	13.45€	75.52€/ud
302132	7 x 35mm	62.78€/ud	13.18€	75.96€/ud
302130	7 x 35mm	43.58€/ud	9.15€	52.73€/ud
302141	7 x 35mm	62.78€/ud	13.18€	75.96€/ud

STYLE

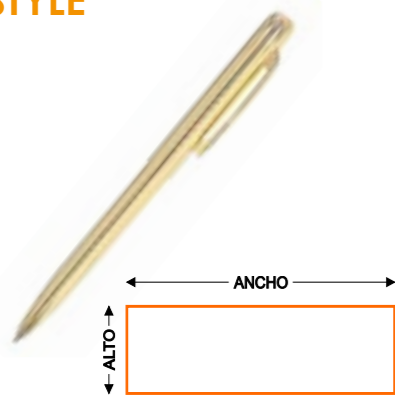

MOD	ALT x ANCHO	PRECIO	IVA 21%	PVP
302120	7 x 35mm	61.82€/ud	12.98€	74.80€/ud
302132	7 x 35mm	55.13€/ud	11.57€	66.70€/ud
302130	7 x 35mm	55.13€/ud	11.57€	66.70€/ud
302141	7 x 35mm	55.13€/ud	11.57€	66.70€/ud

SELLO SECO



CARACTERÍSTICAS

CARACTERÍSTICAS	PRECIO	IVA 21%	PVP
Tenazas con pinza 51mm Ø	33.46€/ud	7.02€	40.48€/ud
Grabación Discos	49.00€/ud	10.29€	59.29€/ud

14 PAPELERÍA

IMPRENTA 14



TARJETAS DE VISITA

MODELO

CANTIDAD

PRECIO

IVA 21%

PVP



55 x 85mm	100uds	30.00€	6.30€	36.30€
Estucado Mate	250uds	42.00€	8.82€	50.82€
350gr	500uds	55.00€	11.55€	66.55€
4X4	1000uds	65.00€	13.65€	78.65€
	2500uds	85.00€	17.85€	102.85€
	5000uds	109.00€	22.89€	131.89€
55 x 85mm	100uds	45.00€	9.45€	54.45€
Plastificado Brillo	250uds	58.00€	12.18€	70.18€
(1 cara)	500uds	70.00€	14.70€	84.70€
350gr	1000uds	86.00€	18.06€	104.06€
Brillo 1 cara	2500uds	98.00€	20.58€	118.58€
4X4	5000uds	114.00€	23.94€	137.94€
	10000uds	290.00€	60.90€	350.90€
55 x 85mm	100uds	59.00€	12.39€	71.39€
Plastificado Mate	250uds	65.00€	13.65€	78.65€
(2 caras)	500uds	79.00€	16.59€	95.59€
350gr	1000uds	93.00€	19.53€	112.53€
Brillo 1 cara	2500uds	120.00€	25.20€	145.20€
4X4	5000uds	162.00€	34.02€	196.02€
	10000uds	304.00€	63.84€	367.84€

Diseño NO incluido.

Hora de diseño/maquetación personalizado: 28€/h.

Para impresiones de 2500 / 5000 00uds, mínimo 8 días hábiles.

Para urgencias, + 30% sobre valor indicado.

TARJETAS PERSONALIZADAS

PERSONALIZACIÓN

PRECIO

IVA 21%

PVP

Silueta troquelada / barniz UVI



Troquel	+ 65.00€	13.65€	78.65€
Tinta UVI	+ 50.00€	10.50€	60.50€

No incluye instalación - No incluyen elementos de sujección

TARJETAS PVC



CARACTERÍSTICAS	PRECIO	IVA 21%	PVP	
55 x 85mm PVC Todo color HD	1 Unidad 25uds 50uds 100uds + de 1000uds	15.00€/ud 4.00€/ud 3.50€/ud 3.00€/ud 2.50€/ud	3.15€ 0.84€ 0.73€ 0.63€ 0.52€	18.15€/ud 4.84€/ud 4.23€/ud 3.63€/ud 3.02€/ud
Barniz Brillo UVI	+1.00€/ud			

TARJETAS PVC TRANSPARENTES



CARACTERÍSTICAS	PRECIO	IVA 21%	PVP	
55 x 85mm PVC Transparente Todo color HD	1 Unidad 25uds 50uds 100uds + de 100uds	15.00€/ud 4.50€/ud 4.00€/ud 3.50€/ud 3.00€/ud	3.15€ 0.94€ 0.84€ 0.73€ 0.63€	18.15€/ud 5.44€/ud 4.84€/ud 4.23€/ud 3.63€/ud
Barniz Brillo UVI	+1.00€/ud			
 Tinta Blanca	+1.00€/ud			

HOJA CORPORATIVA



FORMATO	CANTIDAD	PRECIO	IVA 21%	PVP
Papel A4 90gr 4/0 Impreso a 1 cara Color	50uds	62.00€	13.02€	75.02
	500uds	70.00€	14.70€	84.70€
	1000uds	80.00€	16.80€	96.80€
	2500uds	100.00€	21.00€	121.00€
	5000uds	180.00€	37.80€	217.80€
10000uds	296.00€	62.16€	358.16€	
Papel A4 90gr 4/4 Impreso a 2 caras Color	250uds	82.00€	17.22€	99.22€
	500uds	84.00€	17.64€	101.64€
	1000uds	99.00€	20.79€	119.79€
	2500uds	140.00€	29.40€	169.40€
	5000uds	230.00€	48.30€	278.30€
10000uds	360.00€	75.60€	435.60€	
Papel A4 120gr 4/0 Impreso a 1 cara Color	100uds	180.00€	37.80€	217.80€
	250uds	192.00€	40.32€	232.32€
	1000uds	224.00€	47.04€	271.04€
	2500uds	265.00€	55.65€	320.65€
	5000uds	310.00€	65.10€	375.10€
Papel A4 120gr 4/4 Impreso a 2 caras Color	100uds	254.00€	53.34€	307.34€
	250uds	267.00€	56.07€	323.07€
	1000uds	316.00€	66.36€	382.36€
	2500uds	460.00€	96.60€	556.60€
	5000uds	600.00€	126.00€	726.00€

SOBRE CORPORATIVO



FORMATO	CANTIDAD	PRECIO	IVA 21%	PVP
Sobre Americano 110 x 220mm Impresión 4/0	250uds	120.00€	25.20€	145.20€
	500uds	130.00€	27.30€	157.30€
	1000uds	178.00€	37.38€	215.38€
	2500uds	260.00€	54.60€	314.60€
	5000uds	355.00€	74.55€	429.55€
7500uds	433.00€	90.93€	523.93€	
Sobre C4 229 x 324mm Impresión 4/0	100uds	204.00€	42.84€	246.84€
	250uds	231.00€	48.51€	279.51€
	1000uds	295.00€	61.95€	356.95€
	2500uds	467.00€	98.07€	565.07€
	5000uds	797.00€	167.37€	964.37€
Sobre C5 162 x 229mm Impresión 4/0	100uds	200.00€	42.00€	242.00€
	250uds	216.00€	45.36€	261.36€
	1000uds	261.00€	54.81€	315.81€
	2500uds	443.00€	93.03€	536.03€
	5000uds	630.00€	132.30€	762.30€
	7500uds	863.00€	181.23€	1044.23€

CARPETA CORPORATIVA



FLYERS A6

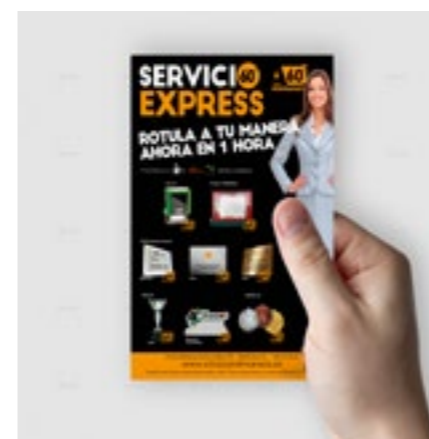

FORMATO	PRECIO	IVA 21%	PVP	
Estucado 300gr 4/4 Tintas Plastificado Brillo	500uds	502.00€	105.42€	607.42€
	1000uds	940.00€	197.40€	1137.40€
Estucado 350gr 4/0 tintas Plastificado mate	500uds	400.00€	84.00€	484.00€
	1000uds	690.00€	144.90€	834.90€
Papel 180gr 4/0 tintas	500uds	190.00€	39.90€	229.90€
	1000uds	295.00€	61.95€	356.95€
Sin solapa plastificado	1000uds	460.00€	96.60€	556.60€
Sin solapa sin plastificado	1000uds	295.00€	61.95€	356.95€
FORMATO	PRECIO	IVA 21%	PVP	
Tamaño A6 105 x 148mm 135gr Todo color 2 caras	1000uds	65.00€	13.65€	78.65€
	2500uds	78.00€	16.38€	94.38€
	5000uds	105.00€	22.05€	127.05€
	7500uds	130.00€	27.30€	157.30€
	10000uds	145.00€	30.45€	175.45€
Papel A6 105 x 148mm 170gr Todo color 2 caras	1000uds	70.00€	14.70€	84.70€
	2500uds	88.00€	18.48€	106.48€
	5000uds	120.00€	25.20€	145.20€
	7500uds	145.00€	30.45€	175.45€
	10000uds	165.00€	34.65€	199.65€

FLYERS A5

FORMATO

PRECIO IVA 21% PVP

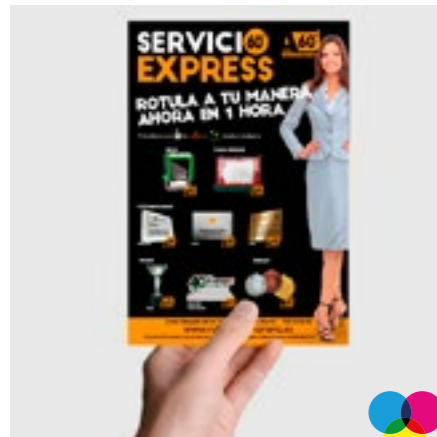

Tamaño A5	1000uds	89.00€	18.69€	107.69€
148 x 210mm	2500uds	125.00€	26.25€	151.25€
135gr	5000uds	180.00€	37.80€	217.80€
Todo color	7500uds	265.00€	55.65€	320.65€
2 caras	10000uds	295.00€	61.95€	356.95€
Papel A5	1000uds	99.00€	20.79€	119.79€
148 x 210mm	2500uds	140.00€	29.40€	169.40€
170gr	5000uds	205.00€	43.05€	248.05€
Todo color	7500uds	299.00€	62.79€	361.79€
2 caras	10000uds	340.00€	71.40€	411.40€

FLYERS A4

FORMATO

PRECIO IVA 21% PVP



Tamaño A4	1000uds	144.00€	30.24€	174.24€
279 x 210mm	2500uds	230.00€	48.30€	278.30€
135gr	5000uds	360.00€	75.60€	435.60€
Todo color	7500uds	490.00€	102.90€	592.90€
2 caras	10000uds	690.00€	144.90€	834.90€

FLYERS DL

FORMATO

PRECIO IVA 21% PVP



Tamaño DL	1000uds	69.00€	14.49€	83.49€
105 x 210mm	2500uds	95.00€	16.38€	114.95€
135gr	5000uds	135.00€	28.35€	163.35€
Todo color	7500uds	170.00€	35.70€	205.70€
2 caras	10000uds	220.00€	46.20€	266.20€
Tamaño DL	1000uds	79.00€	16.59€	95.59€
105 x 210mm	2500uds	105.00€	22.05€	127.05€
170gr	5000uds	150.00€	31.50€	181.50€
Todo color	7500uds	195.00€	40.95€	235.95€
2 caras	10000uds	249.00€	52.29€	301.29€

DÍPTICO / TRÍPTICO

FORMATO

PRECIO IVA 21% PVP



Tamaño A4	1000uds	95.00€	19.95€	114.95€
297 x 210mm	2500uds	141.00€	29.61€	170.61€
1 plegado	5000uds	214.00€	44.94€	258.94€
Todo color	7500uds	279.00€	58.59€	337.59€
2 caras	10000uds	358.00€	75.18€	433.18€
Tamaño A4	1000uds	97.50€	20.47€	117.97€
297 x 210mm	2500uds	180.00€	37.80€	217.80€
2 plegados	5000uds	295.00€	61.95€	356.95€
Todo color	7500uds	397.00€	83.37€	480.37€
2 caras	10000uds	468.00€	98.28€	566.28€

15 SEÑALÉTICA

VÍAS DE EVACUACIÓN SEÑALÉTICA 15



PRECIO IVA 21% PVP

2.95€/ud 0.61€ 3.56€/ud
1.95€/ud 0.40€ 2.35€/ud

+ 10uds

No incluye instalación - No incluyen elementos de sujeción

15 SEÑALÉTICA ADVERTENCIA

CONTRAINCENDIOS SEÑALÉTICA 15



+ 10uds

PRECIO IVA 21% PVP

2.95€/ud 0.61€ 3.56€/ud
1.95€/ud 0.40€ 2.35€/ud



+ 10uds

PRECIO IVA 21% PVP

2.95€/ud 0.61€ 3.56€/ud
1.95€/ud 0.40€ 2.35€/ud

15 SEÑALÉTICA OBLIGACIÓN

PROHIBICIÓN SEÑALÉTICA 15



+ 10uds

PRECIO	IVA 21%	PVP
2.95€/ud	0.61€	3.56€/ud
1.95€/ud	0.40€	2.35€/ud



+ 10uds

PRECIO	IVA 21%	PVP
2.95€/ud	0.61€	3.56€/ud
1.95€/ud	0.40€	2.35€/ud

15 SEÑALÉTICA OBLIGACIÓN

SEÑALIZACIÓN OBRA



422



+ 10uds



Señal de Stop o Circule

PRECIO	IVA 21%	PVP
9.90€/ud	2.07€	11.97€/ud

PRECIO	IVA 21%	PVP
2.95€/ud	0.61€	3.56€/ud
1.95€/ud	0.40€	2.35€/ud

PRECIO	IVA 21%	PVP
Vado	3.78€	21.78€/ud
+ 10uds	3.13€	18.08€/ud
Señal de Stop o Circule	3.78€	21.78€/ud

TEXTIL 16

mimanager

CAMISETAS ESTAMPACIÓN CON VINILO



CARACTERÍSTICAS

Algodón 100% 1ud
Tallas: + de 5uds
S, M, L, XL, XXL + de 10uds
1 estampación + de 50uds
+ de 100uds

2ª Estampación + 5.00€/ud

Incluye Camiseta y estampación.
No incluye diseño/maquetación

PRECIO IVA 21% PVP

15.00€/ud	3.15€	18.15€/ud
13.00€/ud	2.73€	15.73€/ud
10.00€/ud	2.10€	12.10€/ud
7.00€/ud	1,47€	8,47€/ud
6.00€/ud	1.26€	7.26€/ud

CAMISETAS VINOLO IMPRESO



CARACTERÍSTICAS

Algodón 100% 1ud
Tallas: + de 5uds
S, M, L, XL, XXL + de 10uds
1 estampación + de 50uds
+ de 100uds

2ª Estampación + 5.00€/ud

Incluye Camiseta y estampación.
No incluye diseño/maquetación

PRECIO IVA 21% PVP

15.00€/ud	3.15€	18.15€/ud
13.00€/ud	2.73€	15.73€/ud
10.00€/ud	2.10€	12.10€/ud
7.00€/ud	1,47€	8,47€/ud
6.00€/ud	1.26€	7.26€/ud

ESTAMPACIÓN CAMISETAS SERIGRAFÍA



NO INCLUYE CAMISETA

CARACTERÍSTICAS

Algodón 100%
Tallas:
6/7, 8/9, 10/12,
S, M, L, XL, XXL

1 Tinta
1ª Pantalla
+ 36.00€



2 Tintas
2ª Pantalla
+ 56.00€



3 Tintas
3ª Pantalla
+ 72.00€



4 Tintas
4ª Pantalla
+ 88.00€



1 a 100uds
101 a 500uds
+ de 500uds

0.40€/ud	0.08€	0.48€/ud
0.36€/ud	0.07€	0.43€/ud
0.30€/ud	0.06€	0.36€/ud

1 a 100uds
101 a 500uds
+ de 500uds

0.60€/ud	0.12€	0.72€/ud
0.55€/ud	0.11€	0.66€/ud
0.50€/ud	0.10€	0.60€/ud

1 a 100uds
101 a 500uds
+ de 500uds

0.75€/ud	0.15€	0.90€/ud
0.72€/ud	0.15€	0.87€/ud
0.66€/ud	0.13€	0.79€/ud

1 a 100uds
101 a 500uds
+ de 500uds

0.95€/ud	0.19€	1.14€/ud
0.88€/ud	0.18€	1.06€/ud
0.82€/ud	0.17€	0.99€/ud

CAMISETAS SUBLIMACIÓN



CAMISETA INCLUIDA



CARACTERÍSTICAS

	PRECIO	IVA 21%	PVP
Poliéster 100% 1 ud	15.00€/ud	3.15€	18.15€/ud
Color BLANCO + de 5uds	13.00€/ud	2.73€	15.73€/ud
Tallas: + de 10uds	10.00€/ud	2.10€	12.10€/ud
S, M, L, XL, XXL + de 50uds	6.00€/ud	1.26€	7.26€/ud
1 Impresión + de 100uds	5.00€/ud	1.05€	6.05€/ud

2ª Impresión + 3.00€/ud

CAMISETAS SUBLIMACIÓN PLUS



CAMISETA INCLUIDA



CARACTERÍSTICAS

	PRECIO	IVA 21%	PVP
Textura de Algodón 1 ud	17.00€/ud	3.57€	20.57€/ud
Color BLANCO + de 5uds	15.00€/ud	3.15€	18.15€/ud
Tallas: + de 10uds	13.00€/ud	2.73€	15.73€/ud
S, M, L, XL, XXL + de 50uds	11.00€/ud	2.31€	13.31€/ud
1 Impresión + de 100uds	9.00€/ud	1.89€	10.89€/ud

2ª Impresión + 5.00€/ud

PUESTA EN MARCHA 24.80€ +iva

BOLSAS



UDS	PRECIO	IMPRESIÓN	SUBTOTAL	IVA 21%	TOTAL
100 uds	0.80€/ud	1C 0.60€/ud	1.40€/ud	0.29€	1.69€/ud
		2C 1.00€/ud	1.80€/ud	0.37€	2.17€/ud
200 uds	0.80€/ud	1C 0.50€/ud	1.30€/ud	0.27€	1.57€/ud
		2C 0.80€/ud	1.60€/ud	0.33€	1.93€/ud
500 uds	0.78€/ud	1C 0.40€/ud	1.38€/ud	0.28€	1.66€/ud
		2C 0.70€/ud	1.48€/ud	0.31€	1.79€/ud
1000 uds	0.78€/ud	1C 0.40€/ud	1.18€/ud	0.24€	1.42€/ud
		2C 0.65€/ud	1.43€/ud	0.30€	1.73€/ud

MOCHILAS SUBLIMACIÓN



UDS	PRECIO	IMPRESIÓN	SUBTOTAL	IVA 21%	TOTAL
100 uds	2.00€/ud	1C 0.80€/ud	1.80€/ud	0.37€	2.17€/ud
		2C 1.40€/ud	3.40€/ud	0.71€	4.11€/ud
200 uds	2.00€/ud	1C 0.56€/ud	2.56€/ud	0.53€	3.09€/ud
		2C 1.00€/ud	3.00€/ud	0.63€	3.63€/ud
500 uds	1.80€/ud	1C 0.50€/ud	2.30€/ud	0.48€	2.78€/ud
		2C 0.80€/ud	2.60€/ud	0.54€	3.14€/ud
1000 uds	1.80€/ud	1C 0.50€/ud	2.30€/ud	0.48€	2.78€/ud
		2C 0.80€/ud	2.60€/ud	0.54€	3.14€/ud



16 TEXTIL

PUESTA EN MARCHA 24.80€ +iva

GORRA SPORT



	UDS	PRECIO	IMPRESIÓN	SUBTOTAL	IVA 21%	TOTAL
100 uds		0.88€/ud	0.70€/ud	1.58€/ud	0.33€	1.91€/ud
200 uds		0.88€/ud	0.44€/ud	1.32€/ud	0.27€	1.59€/ud
500 uds		0.84€/ud	0.39€/ud	1.23€/ud	0.25€	1.48€/ud
1000 uds		0.84€/ud	0.38€/ud	1.22€/ud	0.25€	1.47€/ud

A Mi Manera Comunicación

 Avda. Marqués de los Vélez 8
30008 - Murcia

 968 23 86 85

 info@rotulossanchez.com

 www.amimaneracomunicacion.com

